

Ngaruawahia
High School
1981

OH, NO! I'VE DONE THE WRONG HOMEWORK!



J. BELL

editorial

A YEAR AT SCHOOL CAN BE APTLY COMPARED TO A SHIP'S VOYAGE, IN THE FACT THAT, IN YOUR TRAVELS ACROSS THE OCEANS OF KNOWLEDGE, YOU ENCOUNTER CALM AND ROUGH SEAS, GOOD AND BAD DAYS, SEA-SICKNESS AND SOMETIMES LOSING YOUR WAY. BUT, AT THE END OF YOUR VOYAGE THERE IS ALWAYS A TREASURE CHEST, A TREASURE CHEST PACKED TO OVERFLOWING WITH GOLDEN MEMORIES. SUCH RICHES ARE KEPT IN YOUR HEAD FOR ETERNITY; HOWEVER, LOCATING THEM OFTEN PROVES MORE DIFFICULT THAN FINDING YOUR HOMEWORK FOR TODAY'S LESSON.

THIS YEAR'S MAGAZINE IS A 'MAP' TO THOSE SPLENDID TREASURES WHICH YOU HAVE BUILT UP OVER THE YEAR. IT IS A 'MAP' THAT ITSELF IS A PRICELESS ITEM, NOT ONLY BECAUSE OF THE WEALTH OF ENTERTAINMENT AND KNOWLEDGE IT CONTAINS, BUT ALSO IN THE MAGNIFICENT COVER - A FIRST FOR THE SCHOOL, AND, AS FAR AS WE CAN DETERMINE, A FIRST FOR A PUBLIC SCHOOL MAGAZINE!

AS THIS MAP LEADS YOU TO THE TREASURE, YOU WILL COME ACROSS MANY SPARKLING DELIGHTS; SUCH AS THIS YEAR'S MAJOR PRODUCTION "ROBYN", WHICH HAD THE MAKINGS OF A ROYAL VARIETY PERFORMANCE; RICH IN TALENT AND ACTION, SHINING WITH COLOUR AND VARIETY, PACKED WITH PUNCH AND PZAZZ; THE ONLY THING MISSING WAS THE ROYAL COUPLE, BUT THAT WAS THEIR LOSS.

ONE OF THE GREATEST DIAMONDS YOU WILL FIND AMONGST THE MANY OTHERS WILL BE THE LIBRARY. WITH INTRICATE CARVINGS, WELL CONSTRUCTED TUKUTUKU PANELS, AND BEING OPENED BY, AND NAMED AFTER, A ROUGH DIAMOND OF OLD, IT WAS MORE THAN JUST A S68 MKIV, IT IS NGARUAWAHIA HIGH'S VERY OWN SIR DOUGLAS CARTER LIBRARY.

SIFTING YOUR WAY THROUGH THE LOOT YOU WILL FIND MANY SPARKLING CLUSTERS OF JEWELS WHICH HAVE SHONE AND SHOWN THE PROWESS ON THE FIELDS AND THE COURTS - THE SPORTING TEAMS THAT HAVE ONCE AGAIN BROUGHT PRIDE TO THEMSELVES AND TO THE SCHOOL. ONE OF THOSE GEMS WAS THE BASKETBALLERS - PROVEN TO BE A VALUABLE ASSET.

AMONGST ANY TREASURE CHEST THERE IS A STONE, AND THIS YEAR'S STONE MUST BE THE "STUDENT COUNCIL'S" MIGHTY MICRO RAFFLE, WHICH DIDN'T MERELY SINK, BUT DROWNED HORRIBLY (MIND YOU, \$1760 IS NOT TO BE SCOFFED AT!).

MANY ADDITIONS WERE MADE TO "THE COLLECTION" THIS YEAR. MOST NOTABLY MRS CHAPPEL, WHO TOOK OVER MRS McNAMARA'S POSITION AS SENIOR MISTRESS. YO HO HO AND A BOTTLE OF RUM, AND DIDN'T THE CORKS FLY AND THE GLASSES CLINK WHEN THE STAFF WON BACK THE COVETED "CHALLENGE SHIELD" IN A BRILLIANT GAME OF RUGBY.

UNDOUBTEDLY THE MOST PRECIOUS DISCOVERY IS WHEN YOU FIND YOUR NAME OR EVEN YOUR PHOTOGRAPH. SO READ, ENJOY AND REMINISCE ABOUT YOUR MIGHTY VOYAGE OF 1981.

A. Stevens

J. J. Henderson

P. Broadly

Leanne Cyril

ROBYN



Robyn (Natalie Fair) and the evil Sheriff of Nottingham (Dale Timms) confront each other.

The Spirit of Adventure

This year's major stage production was the New Zealand composed musical "ROBYN", words by John Reynolds and music by Gary Daverne. The story started with a schoolgirl falling asleep and dreaming that she was the outlaw Robyn Hood. Most of the show was in fact Robyn's dream and involved all the usual Robyn Hood type adventures including the rescue of the beautiful Princess Phillipa who had been captured by sheriff's soldiers so that he could force her to marry him.

One of the most satisfying aspects of the production was the wide range of personnel involved. Older teachers, younger teachers, parents, senior pupils and junior combined together to form a united team.

An obvious expression of this unity was

seen at the end of the first performance during the final curtain call song, with the spontaneous, enthusiastic and joyful interaction of the whole company. Dale Timms as the sheriff and Donna Ranga as Princess Phillipa reached their usual high standard while new star Natalie Fair gave an excellent performance. But these stars couldn't have shone without the backing of the enthusiastic and dedicated supporting cast—especially Robyn's Band of Merry "Men".

Behind every show there is a production team, and "Robyn" was no exception. About ten staff members were a major part of the success of the show. Mr Sargeant contributed enormously to the show with his previous experience in producing past performances, we all

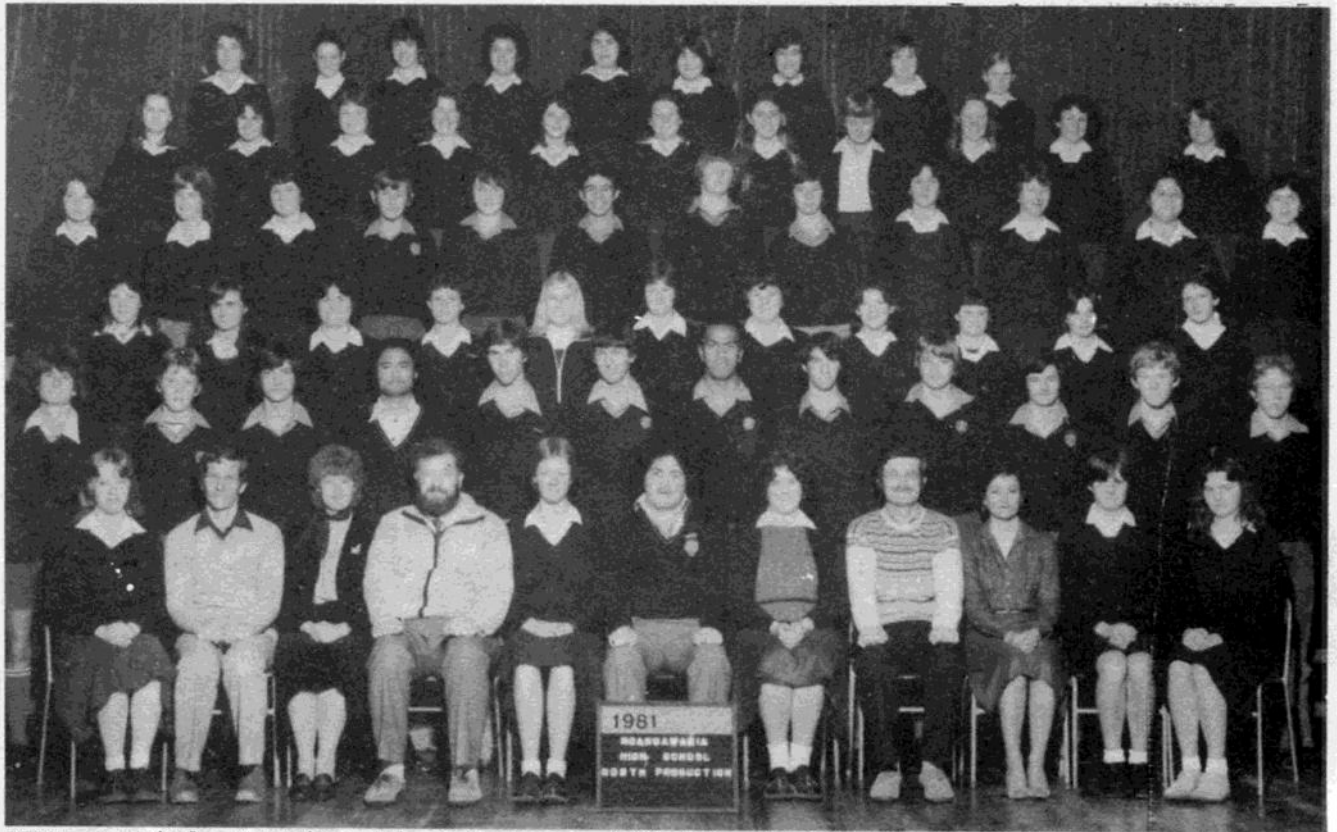

REAR: A.Baird, R.Schimanski, S.Frangos, C.Winikerei, F.Matthews, G.Blisset, W.Zimmerman, C.Docherty, R.Preston.
 5th ROW: H.Scandlyn, D.Pavich, J.McLan, T.Smith, M.Reynolds, H.Litt, V.Wallbank, H.Johnson, D.Collins, S.Fisher.
 4th ROW: N.Preston, W.Gibb, C.Gould, D.Parrish, K.Hooker, C.McRoberts, J.Bradshaw, S.Chrystall, L.Osborne, M.Campbell, K.Smith, L.Hutt.
 3rd ROW: P.Thackray, M.Jeanes, A.Middleton, S.Puncheon, K.Gothorpe, G.Runciman, G.Hartstone, S.Parker, C.Rogers, K.Singh, V.Buchanan.
 2nd ROW: J.Bell, R.Coenen, S.Cocup, G.Simon, R.Connolly, D.Taylor, J.Tahana, S.Schreiber, A.Holden, G.Wood, C.Herdman, M.Tournier.
 SEATED: R.Pritchett, P.Mans, J.Schaare, J.Sergeant, V.Taylor, D.Timms, N.Fair, A.Johnson, F.Van Dam, D.England, C.Bullen. (3)

remember "The Happiest Days of Your Life".

Associate Producers Mrs. Schaare and Mrs Van Dam kept close eye on things behind the scenes, especially at rehearsals.

As in any production there were several company disagreements which they ably ironed-out and kept well under control. It was with their help that Robyn ran smoothly all three nights.

Mrs. Storey and Mrs. Cameron succeeded in doing a fantastic job of choreography. The dance routines they designed were a real credit to them.

The show could not have gone on without Mrs H. Preston and Mrs J. Wardell.

(4)

Their expertise in the designing of costumes really showed. The visual effect on stage was unreal.

Mr Mans was responsible for the terrific lighting and sound effects which added glamour to the show.

Mr. Johnston was the great musician behind it all, using his musical talents to the utmost.

This great team made 'Robyn' possible and it's to them we all owe our greatest thanks. We congratulate them on a fabulous show.

Vivienne Taylor.



BERTRAM AND RENALDO? GEORGE SIMON APPEARS TO MEET UP WITH HIMSELF FOR THE FIRST TIME! George's characterisation did much towards the sparkle of the production, and was in marked contrast to his sports-field role as 1st XV Captain. A great performance lad!

The Spirit of Adventure

The Spirit of Adventure.

On Tuesday 20th of January 1981, I was selected to go on a once in a life time sailing experience on the Spirit of Adventure. This particular voyage was from Auckland to Napier, a 10 day sailing excursion. Six officer's and twenty five trainees from all over New Zealand formed the crew. The 25 trainees were divided into three watches - red, white and blue; of course white was the best, which I was put in. Each watch had a certain sector of the ship to be responsible for, also including kitchen duties of (wash the dishes, dry the dishes, turn the dishes over). There were lectures on such subjects as Navigation, Anchoring, Emergency Equipment, Compass construction, Sailing theory, meteorology and Practical lectures on ropework. One of my dislikes, of the voyage was getting up at 5.30 a.m to go for a swim, which was very unpleasant, or in other words bloody terrible. But this was a routine which had a purpose. One piece of item which did not require lectures on, but had to be followed by precise instruction was the heads (Toilet). This item required vigorous and strenuous pumping action to flush, after your daily succession. The highlight of the voyage was a two day stop over at Mahia Peninsula. We were allowed to explore this peninsula to find and study unique sealife, certain species of seabirds, and fluctuated sun tanned bodies resting upon the beach (GIRLS). Entering the Hawke Bay harbour where Napier is located we finally reached our destination the tenth day. On reflection, the voyage proved very enjoyable and especially the rewarding efforts I put into the voyages was worth it. As a result of my efforts I had gained and presented to me a silver mounted trophy replica of the Spirit of Adventure, valued at \$5,000.00 for the most improved trainee. So I hope in the future, pupils within the school who are selected to Voyage the Spirit of Adventure, will try hard to achieve this.

Joseph Tahana.

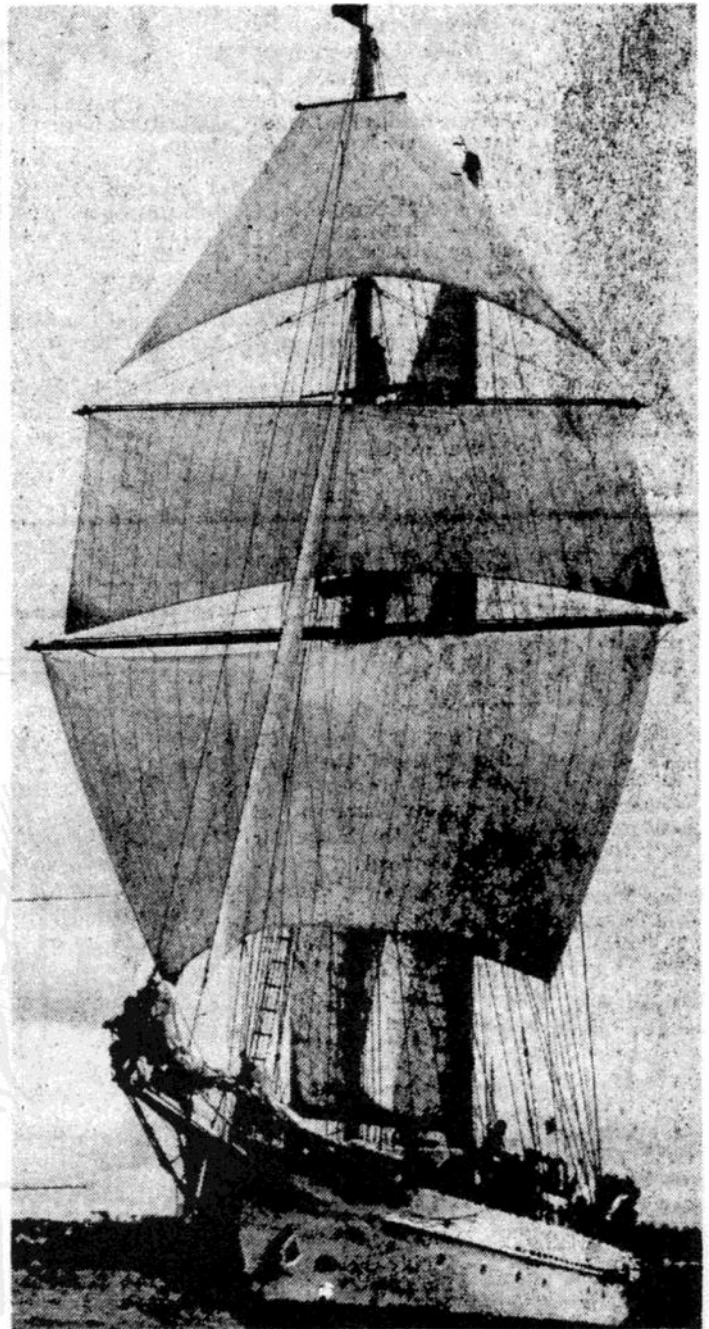

(5)

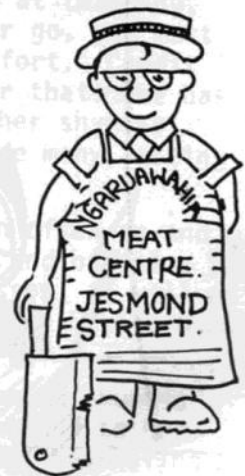

WATERSKIING

Last summer several groups of students accompanied Mrs Cameron and took the opportunity to learn to waterski at the Ngaruawahia Waterski Club, on the banks of the Waikato River (access through the Ngaruawahia Golf Club grounds).

These groups gained a great deal of success in their first time up, with some of the students returning to the Club on Sundays and eventually becoming members.

The Club is managed by mainly ex-students, many of whom have gained recognition in competition; such as Alan Harrop, Ron McLean, Craig Gutry, Andrew Pharo and Rodney Gutry. The Ngaruawahia Ski Club was placed 4th in New Zealand in the 1981 New Zealand National Barefoot Ski Championships.

Students have always been welcome at the Club, and those who have made the time to extend their experiences have been grateful for the opportunity provided by their hosts. All they needed to take was their swimming gear - the Club provided everything else.

Our thanks go to Mr Gutry for his encourage ent of an exciting and skilfull sport as another outlet for our student's talents. Mr Gutry still encourages new students to make the most of the opportunities available in this water-sport, and they may contact.him at 8866 or 8078 (evenings).

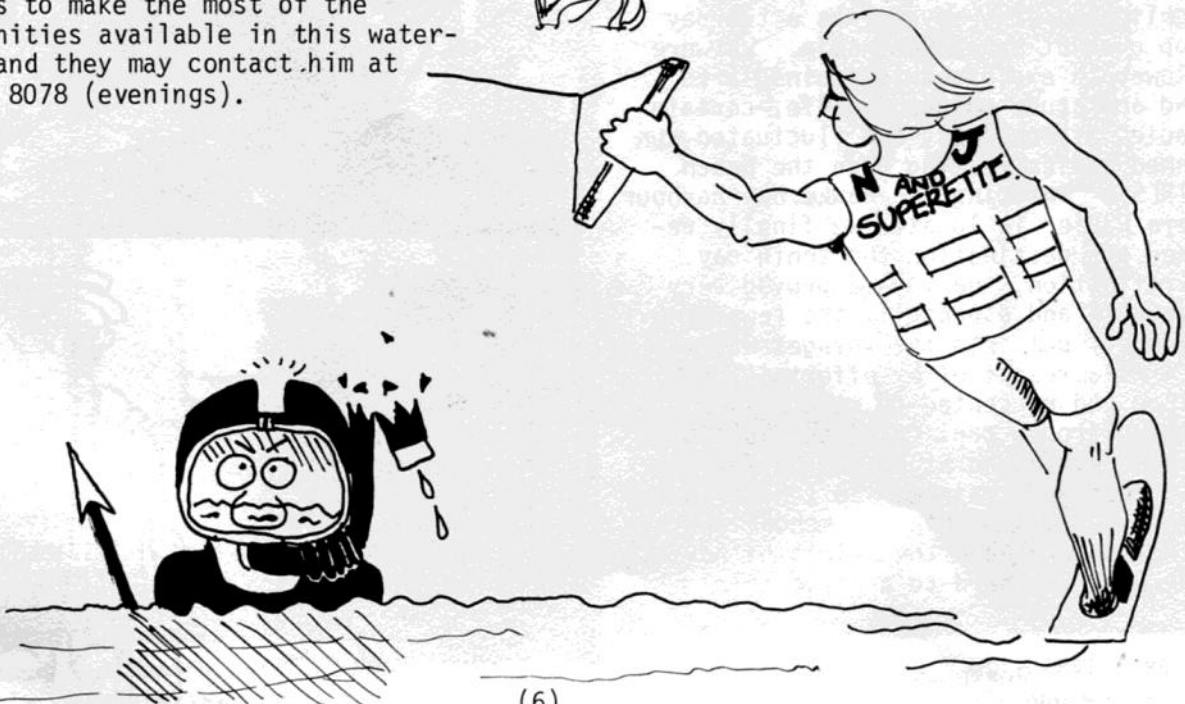
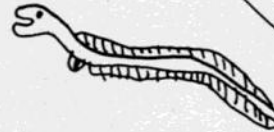
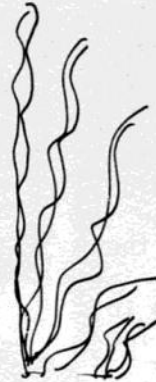

INTER-HOUSE

For the past three years the Founders' Shield, symbol of Inter-House Competition, has been monopolised by Newcastle. However it was the intention of Tainui to throw a spanner into the Newcastle machine this year, and throw it did! Newcastle stripped of a few teeth were made to earn their salt, if they could.

Tainui lifted its head and roared out a comprehensive victory salute to start the year off in the Swimming Championships.

Newcastle replied with a late burst to take out the Athletics while Maniapoto demonstrated its organisational ability and streaked home in the fund-raising for Gala Day.

Then Newcastle showed its concern for others by taking the three Community Service activities, with Havelock starting to bestir themselves in this area also. Two visits by the Blood Transfusion Unit saw a "cut-throat" sense of competition amongst the seniors with honours being evenly shared with a great response by all four Houses.

By this stage Tainui was not without a chance in second spot behind Newcastle. A magnificent effort resulted in their participation in the Cross Country and they took the teams events almost without challenge. They again came to the fore by having the highest average earnings on workday and coming second to Maniapoto in the Indoor Basketball Competition.

However, it seemed that Newcastle had just done enough to keep their collective nose out in front and took the Shield for an unprecedented fourth successive year!

EVENT	H	M	N	T
Swimming Champ's	4th	3rd	2nd	1st
Athletic Champ's	3rd	4th	1st	2nd
Gala Day Fundraising	4th	1st	2nd	3rd
I.H.C. Collectors	3rd	4th	1st	2nd
Red Shield Collectors	2nd	3rd=	1st	3rd=
Handicap Runners	2nd	4th	1st	3rd
Blood Donors (March)	1st	3rd	2nd	4th
Blood Donors (Sept.)	4th	3rd	1st=	1st=
Cross Country	4th	2nd	3rd	1st
Work Day Earnings	4th	3rd	2nd	1st
Mighty Micro Raffle	4th	3rd	1st	2nd
Indoor Basketball	4th	1st	3rd	2nd
FINAL PLACINGS	4th	3rd	1st	2nd

SWIMMING

Junior Girls:

- 1x F/S. M.Simeon-C.Prendergast-J.McLean
- 1x Bk/S. M.Simeon-C.Prendergast-J.McLean
- 1x Br/S. M.Simeon-L.Hanes-J.McLean
- 3x F/S. M.Simeon-C.Prendergast
- 3x Bk/S. No entries
- 3x Br/S. M.Simeon
- 3x Medley No entries

Intermediate Girls:

- 1x F/S. J.Plummer-D.Turton-N.Hinton
- 1x Bk/S. J.Plummer-D.Turton-N.Hinton
- 1x Br/S. J.Plummer
- 3x F/S. D.Turton-N.Hinton
- 3x Bk/S. D.Turton
- 3x Br/S. J.Plummer
- 3x Medley J.Plummer

VALEDICTORY



After a three-year period of teaching here, Mary-Ann Curtis returns to her former profession as Laboratory Technician at the Ruakura Research Centre. Her enthusiasm in both the classroom and on the sportsfield has gained her wide recognition and respect amongst staff and students alike.

Over the years junior maths and science have been her concerns but latterly a senior maths class has seen her enjoyably involved.

"If you want to succeed at teaching, and give the kids a fair go, you must put in much time and effort." Credit is certainly due to her for that. She has found she has overcome her shyness through teaching and made many lasting friendships.

Mrs Curtis has been seen often on and around the hockey field and has also been involved in macrame classes, as well as staff representative on the Senior School Council.

With a change in vocation Mrs Curtis will have more time to attend to her interests such as sailing, snorkeling and scuba diving.

Senior Girls:

1x F/S. M.Prendergast-S.Fisher-V.Taylor
1x Bk/S. M.Prendergast-V.Taylor-S.Fisher
1x Br/S. W.Nuzum-M.Morgan
3x F/S. M.Prendergast-S.Fisher-V.Taylor
3x Medley S.Fisher-W.Nuzum
3x Bk/S. M.Prendergast
3x Br/S. S.Fisher-W.Nuzum-M.Morgan

Girls Open:

6x F/S. J.Plummer-T.Reynolds
1x Butterfly S.Fisher-W.Nuzum

Age Races:

-13 1x F/S K.Henery-R.Pritchett-K.Andrews
1x Br/S. C.Mills-F.Matthews-K.Henry
-14 1x F/S. J.Hartstone-R.Cairns-L.Rogers
1x Br/S. R.Commins-A.Brown-D.Pavich
-15 1x F/S. B.Law-B.Bailey-S.Tancred
1x Br/S. S.Tancred-L.Solomon-B.Law
-16 1x F/S. S.McBurney-T.Rowe-C.McSweeney
1x Br/S. S.McBurney-J.Owens
+16 1x F/S. V.Head-C.Fletcher-M.Esselbrugge
1x Br/S. C.Fletcher-J.Hartstone

Relays:

Junior Girls: Havelock-Maniapoto-Newcastle
Int. Girls: Tainui-Havelock-Maniapoto
Senior Girls: Newcastle-Tainui-Maniapoto

Junior Boys

1x F/S. D.Griffiths-T.Gray-J.Bradshaw
1x Bk/S. D.Griffiths-T.White-S.Allan
1x Br/S. T.White-D.Griffiths-J.Bradshaw
3x F/S. T.White-D.Griffiths-J.Bradshaw
3x Bk/S. No entries
3x Br/S. J.Bradshaw
3x Medley D.Griffiths-T.White-J.Bradshaw

Intermediate Boys:

1x F/S. P.Rawiri-A.Haultain-T.Young
1x Bk/S. C.McRoberts-D.Miller-A.Collins
1x Br/S. D.Miller-A.Haultain-A.Pharo
3x F/S. C.McRoberts-A.Haultain-A.Collins
3x Bk/S. C.McRoberts
3x Br/S. C.McRoberts-A.Haultain
3x Medley C.McRoberts-T.Young

Senior Boys:

1x F/S. R.Connolly-R.Wall-Z.Cathro
1x Bk/S. B.Williams-R.Wall-P.Lornie
1x Br/S. R.Connolly-E.Nikora-R.Wall
3x F/S. R.Connolly-Z.Cathro-P.Lornie
3x Bk/S. Z.Cathro
3x Br/S. R.Connolly-Z.Cathro-B.Williams
3x Medley R.Connolly-Z.Cathro-B.Williams

Boys Open:

6x F/S. C.McRoberts-R.Connolly-Z.Cathro
1x Butterfly C.McRoberts-Z.Cathro-R.Connolly

Age Races:

-13 1x F/S. P.Harding-C.Clarke-W.Muru
1x Br/S. S.Hewetson
-14 1x F/S. P.Rawiri-R.Benny-D.VanWoerden
1x Br/S. M.Kaio-D.Stephens-K.Herangi
-15 1x F/S. A.Lewin-R.Salt-O.Allison
1x Br/S. A.West-M.Tournier
-16 1x F/S. H.Muru-M.Simon-H.Lovell
1x Br/S. M.Simon-P.Clarke-H.Lovell
+16 1x F/S. J.West/H.Muru-B.Harding
1x Br/S. J.West-B.Harding-G.Johnstone

Relays:

Junior Boys: Newcastle-Tainui-Havelock
Int. Boys: Newcastle-Tainui-Maniapoto
Senior Boys: Maniapoto-Newcastle-Tainui

CHAMPIONS

Junior Girls M.SIMEON
Intermediate Girls J.PLUMMER
Senior Girls M.PRENDERGAST
Junior Boys D.GRIFFITHS
Intermediate Boys C.McROBERTS
Senior Boys R.CONNOLLY

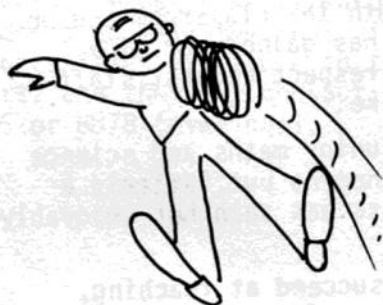

WAIKATO
WATCH
REPAIRS

JESMOND ST.

A TYPICAL SCHOOL MORNING

by JACKIE ALLEN

You hear the kids outside the busstop yelling that the bus is coming. You grab some money for your lunch and run out in the rain just as the bus begins to pick up speed. You fall up the steps and find yourself a seat at the back of the bus.

You look down at how much money you got to see if you could get one of those apricot pies that you plan to throw at your worst enemy - your teacher. You look around in despair as you see you grabbed the pile of play money your sister plays shops with. The bus stops and someone gets on coughing like that old man down the road who smokes two packets a day. He walks towards you and the bus takes off suddenly. He isn't ready for this and loses his balance, grabs hold of the bar on your seat and coughs in your face. You're highly disgusted with this and go and sit at the front of the bus where you think it's safer.

Little do you know that the next person who gets on would be carrying bags full of stuff for the gala day. And little did you know she would slip on the floor and drop all her yoghurt and sticky sweets into your lap. You decide to sit right up the very front with the bus driver and as you go to step up there, a gust of wind blows in through the open door and sends your gym up around your ears. You feel yourself burning up with embarrassment and anger when you hear someone yells out "Look she's got blue knickers On!".

You arrive at school and walk to your locker. You discover someone else's books in there, and look around to see if anyone's watching and when you see there isn't, you yank them all out and throw them to the floor. You're feeling pretty proud of yourself for that sudden show of bravery and proceed to put your books in. Until you hear someone ask what you did that for. You turn around terrified, and see the biggest kid in the school glaring at you. You stand there in a cold sweat and pick up the books. Then you take out yours to replace with others.

You give one look at the other person and run for your life, dropping your pencil case.

Period 1: English - You curse yourself for not preparing that speech you had for homework and reluctantly write your name on the board for a detention.

Period 2: Social Studies - You still can't work out what that funny looking country (9)



is just across from Australia. Interval comes and you and your mates go behind the trees for a fag and find out no one has any. You decide to go to your locker for next periods books, but discover your new-made enemy in there again and ask if he'd seen your pencil-case. He gives you one of those glares and you're off again. Period 3: Maths - You're late and told to sign the late book. You're caught as you walk to the office and are asked if you have a note. You say "No" and are marched up to the DP's office. Your punishment is picking up leaves around the garden. You say you won't stoop so low, but do it anyway. It takes you half an hour to do this and as soon as you finish you go straight to your locker, get all your chewing gum, and chew it up! You tell your mates to do the same and you stick gum in all the locks of all the classrooms and disappear into town. And that is a typical school morning!!!

athletics

ATHLETIC CHAMPIONS 1981

Junior Girls

1. K.Stirling
2. G.Blissett
3. D.Head

Inter. Girls

1. J.Plummer
2. P.Thackray
3. A.Middleton

Senior Girls

1. T.Roe
2. C.Fletcher
- D.Barakat

Junior Boys

1. P.Clarke
D.Lauder
3. G.Winchcombe

Inter. Boys

1. H.Muru
2. P.Rawiri
3. P.Hodgkinson

Senior Boys

1. R.Wall
2. R.Connolly
3. W.Muru/J.West/P.Lornie



ROSS WALL (left) AND CHRIS GRINTER
BATTLE OUT THE LAST LEG OF THE
STAFF v. SENIORS 4x100m RELAY, WON
ON THIS OCCASION BY THE SENIORS.

Ross Wall holds the Senior 200m
Sprint Record of 24.6 while Chris
Grinter remains with his record
of 24.8 for the 220 yards set in
1967. Much discussion goes on as
to who had the faster pace at their
respective years.

ATHLETIC PERFORMANCES 1981

Junior Boys: 100m D.Lauder; 200m J.Morunga; 400m P.Clarke; 800m G.Winchcombe; 1500m G.Winchcombe; 100m Hurdles R.McIntosh; Shot P.Clarke; Discus P.Clarke; Long Jump R.McIntosh; Triple Jump D.Fairweather; High Jump D.Lauder; Javelin T.Gray; Relay Newcastle.

Int. Boys: 100m H.Muru, 200m H.Muru; 400m J.Hona; 800m P.Hodgkinson; 1500m A.West; 100m Hurdles A.Mataāhi; Shot P.Rawiri; Discus P.Rawiri; Long Jump T.Rakena; Triple Jump H.Muru; High Jump J.Bell; Javelin R.Salt; Relay Newcastle.

Senior Boys: 100m R.Wall; 200m R.Wall; 400m R.Wall; 800m P.McMillan; 1500m P.Lornie; 100m Hurdles R.Connelly; Shot H.Muru; Discus B.Williams; Long Jump W.Muru; Triple Jump R.Wall; High Jump B.Harding; Javelin M.Williamson; Relay Maniapoto.



Junior Girls: 100m D.Head; 200m D.Head; 400m M.Sketchley; 800m K.Stirling; 1500m G.Blissett; 100m Hurdles K.Stirling; Shot N.Henare; Discus M.Simeon; Long Jump A.Haman; High Jump A.Todd; Javelin S.Muru; Relay Tainui. Triple Jump K.Exell.

Int. Girls: 100m P.Thackray; 200m P.Thackray; 400m J.Plummer; 800m J.Plummer; 1500m J.Plummer; 100m Hurdles K.Ngaratata; Shot A.Middleton; Discus A.Middleton; Long Jump W.Hansen; High Jump B.Bailey; Javelin L.Rogers; Relay Newcastle; Triple Jump S.Houghton.

Senior Girls: 100m T.Roe; 200m C.Fletcher; 400m V.Taylor; 800m D.Barakat; 1500m D.Barakat; 100m Hurdles C.Fletcher; Shot R.Tini; Discus R.Parata; Long Jump V.Head/L.Clay; High Jump V.Taylor; Javelin L.Paekau; Relay Maniapoto.

ATHLETIC RECORDS SET 1981

S.Girls High Jump - Vivienne Taylor (1.52m)
I.Girls 100m - Paula Thackray (13.8s)
J.Girls 200m - Dallas Head (28.7s)
J.Boys 200m - Jodi Morunga (26.1s)
I.Boys High Jump - John Bell (1.66m)
S.Boys 200m - Ross Wall (24.6s)



Vivienne Taylor on her way to setting a new high jump record.



"GET UP, PHARO!
GET UP!"

Staff Relay team that competed against the Senior Students at the School Athletic Championships. Chris Grinter, Paul Philips, Arnie Paurini, Richard Wiglesworth and team coach Saarda Wiglesworth.

HARRIERS

This year the Harriers team has been strong. The strength has been in the number of girls involved, greatly outnumbering the boys.

There was not very much inter-school

competition, with a welcome run against Hillcrest, to whom we lost.

We lost Julie Roe during the year, but the squad still carried on with the encouragement and handy help in the form of Ms Stone.

- Gail Blissett



REAR: S.Dass, L.Frater, M.Jeanes, S.Parker, S.Houghton, A.Matthews, M.Reynolds, L.Stone.
SEATED: G.Blissett, S.Chrystall, S.Meyers, S.Solomon, K.Exell, G.Oliver, F.Matthews.

Waikato SS Cross Country

From 10:30am until 4:30pm Saturday 24th October this year Te Aroha College hosted our Cross Country Team. Strong wind and rain greeted us on a course that was fast and undulating. This suited the more experienced runner.

We found that most of the events were won by Waikato Champions, and they set a very high standard in all events.

Most races went off at a fast pace, especially in the Senior Boys and the Senior Girls events where competition was tough.

We can be very proud of our school representatives who had a good competitive spirit and set out to do well for the school.

RESULTS

Junior Girls:
Denise Collins 26th
Queenie Matatahi 33rd
Kate Henry 63rd
Stephanie Frater 64th



Junior Boys:

Grant Winchcombe 39th
Jack Tahana 50th
William Taha
Darren Rapana

Intermediate Girls:

Leslie Gurnick 33rd
Jan Plummer 43rd
Maree Jeanes 44th
Kaye Perham

Intermediate Boys:

Aaron West 43rd
Robert McSweeney 55th
Alan Lewin 59th

Senior Boys:

Peter Lornie 28th
Justin West 36th

Senior Girls:

Tracey Roe 12th
Wendy Nuzum 22nd
Dale Barakat

(13)

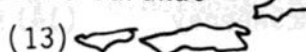

- Tim Callaghan



Cross country

JUNIOR GIRLS

1. D.Collins (19m 53s)
2. F.Matthews
3. Q.Matatahi
4. K.Exell
5. K.Henry
6. S.Frater
7. L.Hutt
8. K.Stirling
9. H.Whitfield
10. G.Blissett
11. L.Hanes
12. R.Preston
13. A.Todd
14. J.Capper
15. R.Schimanski
16. K.Rogers
L.Rogers
18. C.Harrison
19. J.Hodge
20. S.Acherman
21. R.Commins
22. K.Gould
23. A.Brown
24. K.Schreiber
25. B.Smith
26. J.Frankhauser
27. J.McLean
28. S.Frangos
29. D.Head
30. D.Mahara
31. D.Attrill
32. N.Henare
33. D.Ruapapere
34. H.Paul
35. N.Turner
36. K.Bruce
37. V.Wallbank
38. T.Duffel
39. J.Hartstone
40. E.Hintz
41. M.Salt
42. H.Litt
43. P.Hopa
44. D.Mitchell
45. S.Tipping
46. E.Sam
47. G.Murdoch
48. S.Bridgeman
49. R.Derecourt

INTERMEDIATE GIRLS

1. J.Plummer (20m 4s)
2. S.Parker
3. L.Gurnick

4. A.Matthews
5. K.Perham
6. M.Jeanes
7. L.Osborne
8. A.Baird
9. D.England
10. J.Owens
11. M.Reynolds
12. M.Mahara
13. T.Abbot
14. T.Stephens
15. W.Hansen
16. L.Mills
17. M.Tyrie
18. R.Menzies
19. L.Meahger
20. B.Cocup
21. G.Hartstone
22. W.Smith
23. D.Vincent
24. J.Dalbeth
25. F.McNally
26. T.Campbell
27. V.Buchanan
28. J.Collins
29. L.Ridley
30. A.Hopa
31. C.Rogers
32. B.Law
33. S.Todd
34. D.Sargent
35. D.Turton
36. B.Ashley
37. H.Ringrose
38. S.McBurney
39. C.Nelson
40. S.Tancred
41. S.Gurmel
42. E.Vandy
43. E.Mountney
44. C.Docherty

SENIOR GIRLS

1. D.Barakat (18m 10.5s)
2. L.Park
3. T.Rowe
4. W.Nuzum
5. V.Taylor
6. T.Smith
7. M.Morgan
8. M.Prendergast
9. R.Nikora
10. H.Johnston
11. S.Dass
12. R.Davies
13. C.McSweeney

14. H.McLean
15. J.Hartstone
16. L.McLean
17. L.Tyrie
18. R.Taylor
19. S.Mataafe
20. C.Crawford

JUNIOR BOYS

1. J.Tahana (34m 30s)
2. S.Allan
3. S.Harrison
4. T.White
5. G.Williams
6. D.Fairweather
7. W.Taha
8. J.Morunga
9. D.Rapana
10. K.Stirling
11. S.Miller
12. D.Stephens
13. J.Bradshaw
14. A.Evitts
15. M.Ringrose
16. G.Winchcombe
17. R.Benny
18. J.Owens
19. P.Harding
20. B.Smith
21. M.McLaren
22. S.Crowhurst
23. D.Allison
24. D.Parrish
25. R.Hinsch
26. A.Begbie
27. B.Gurmel
28. P.Clarke
29. A.Raraka
30. R.Turu
31. C.Henare
32. J.Luff
33. C.Torrington
34. S.Odlum
35. R.Hill
36. D.Prendergast
37. B.Maley
38. T.Gray
39. D.Ruapapere
40. S.Smith
41. B.Borrell
42. G.Paul
43. B.Anderson
44. S.Vandy
45. N.Newport
46. C.Bridgeman
47. C.Jamieson
48. T.Middleton
49. R.Barton
50. G.Vernall
51. R.Gillies

52. C.Tengu
53. A.Paekau
54. G.Peebles
55. M.Brown
56. D.Frankhauser
57. D.Griffiths
58. W.Sweet
59. S.Crowther
60. P.Gill

INTERMEDIATE BOYS

1. A.West (30m 30s)
2. A.Pahro
3. R.McSweeney
4. S.Johnston
5. S.Chrystall
6. R.McIntosh
7. P.Hodgkinson
8. G.Fletcher
9. A.Lewin
10. L.Henare
11. S.McLaren
12. R.Martin
13. E.Stokes
14. R.Gutry
15. M.Nikora
16. A.Collins
17. D.Everleigh
18. P.Vandy
19. M.Hartstone
20. D.Bright
21. K.Robertson
22. A.Haultain
23. D.Hodge
24. L.Turner
25. K.Morgan
26. C.Renata
27. S.Willey
28. K.Hooker
29. P.Frangos
30. J.Hitchens
31. M.Collis
32. D.Puncheon
33. B.Mahara
34. J.Duffull
35. J.Houghton
36. J.Wilson
37. A.Holloway
38. W.Mackrell
39. C.Herdman
40. M.Stevens
41. T.Rakena
42. G.Cleland
43. M.Williamson
44. O.Allison
45. L.Waitere
46. R.Oliver
47. B.Carter
48. B.Sargent



REAR: J.Morunga, P.Clark, R.McIntosh, K.Stirling, T.Rakena, J.Bradshaw, D.Lauder.
 3rd ROW: L.Hutt, D.Head, M.Sketchley, R.Davies, D.Barakat, M.Jeanes, A.Matthews, A.Todd, K.Rogers.
 2nd ROW: A.West, J.West, R.Wall, R.Connolly, L.Williamson, E.Nikora, P.Lornie, G.Winchcombe, A.Paurini.
 SEATED: G.Blissett, S.Muru, S.Parker, D.England, K.Exell, N.Henare, J.Plummer, L.Rogers, F.Matthews.

SENIOR BOYS

1. P.Lornie (29m 20s)
2. P.McMillan
3. J.Bell
4. G.Wood
5. B.Harding
6. M.Van Tiel
7. E.Nikora
8. S.Solomon
9. R.Wall
10. Hekewaru Muru
11. B.Sweet
12. P.Clark
13. R.Connolly
14. S.Paul
15. G.Ridley
16. K.McKee
17. J.Tahana
18. B.O'Hearn
19. K.Magee
20. A.Paul
21. G.Johnson
22. D.Sam (15)

23. L.Williamson
24. Hurunui Muru
25. J.West
26. G.Simon
27. S.Schreiber
28. G.Collis
29. H.Lovell
30. D.Timms

INTER-HOUSE RESULTS

<u>Boys:</u>	1.	2.	3.	4.
Junior	M	N	T	H
Inter.	T	N	M	H
Senior	T	M	N	H
<u>Girls:</u>				
Junior	T	M	H	N
Inter.	T	M	N	H
Senior	M	T	H	N



J.Morunga, P.Clark, R.McIntosh, D.Lauder.

THE CAUSE OF VIOLENCE IN OUR SOCIETY

It's an ordinary weeknight, well ordinary for most people. But not for little Johnnie. Johnnie has a black eye, cut lip, various bodily bruising and a possible broken arm. Been out fighting with his mates, you think. But NO!. It's his dad's idea of a mild punishment. And Johnnie's one of the lucky ones he hasn't lost his sight by a slap with a budded belt across his face or been whipped with an electric jug cord. Then there's Mrs Smith, she's a mother of two and pregnant. She's just been bashed up and kicked in the stomach by a drunk husband. Both those people are victims of domestic violence.

There are a few laws which try to deter people who are violent in a family situation but often the wife has no personal money and nowhere to go. There are various Half-Way Houses around N.Z. for battered women but not nearly enough to help all those in need. They just don't receive the aid, especially financial, that they need. Do you know, that in

most cases of domestic murder, assault or rape the assailant is well known to the victim, a friend or family. But society doesn't want to know, it ignores this fact and pretends that all you have to do is: not talk to strangers and not go out on the streets at night, and you'll be safe. You hope.

And what about Mr. Jones he's just been bashed up by his wife. That's what the rest of society does, but it doesn't help the victim much does it? In most cases of husband bashing the thought of being publicly humiliated in a court stops them from taking any sort of action. These men are abandoned by society and for the rest of their lives are haunted by the knowledge that no-one cares. No-one cares because they are men, they are the ones stereo-typed as the protectors and strength in a community. And because of this they are ignored and shunned by the rest of society.

So although it is basically women and children who get bashed up, men do to. (16)

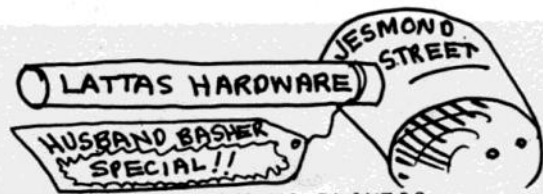

BUT WHO IS REALLY TO BLAME??

The husband, wife or parent who does the bashing? No, look deeper and you will see that a lot of it stems from society's attitudes towards violence. It is society which condones certain aspects of violence says men who get assaulted by women are cowards and that women who get raped asked for it.

Perhaps you are wondering how society condones violence. Well, what corporal punishment in schools. Corporal punishment is still used as a deterrent for trouble makers and nuisances. But look at the list of people caned and you'll see the same names recurring. There is even the paradoxical situation of a boy being caned for fighting in the school grounds. Punishing violence with violence, what on earth is that supposed to teach the boy. The only thing which this form of legitimate violence does and studies have proven, it is to turn these kids into tomorrow's future violent offenders.

And that's not the only form of condoned violence in our society. What about our national sport. Good old Rugby! At times it is hard to tell if it's a rugby match going on or a free for all brawl in the centre of the field. But who cares? Because it is occurring in our national male sport and no-one bats an eye and besides a few good punches liven up a game especially if your side is on the safer end of the fists.

What about when scrums were collapsed and a neck got broken, who got blamed for that act of violence, certainly not the true culprits, not society. It just looks the other way, as usual.

It is an act of violence, yet why does the fact it's being done by teams on a field excuse it. What makes these men any different from Mrs. Smith's husband or Johnnie's dad. There is no difference and yet nothing is done about it.

So really it is no wonder that the kids of today are growing up to become confused adults, unable to distinguish between illegal and condoned violence. Look at the last generation. They've grown up with legal violence and now we have the highest rate of domestic



Inter-House

BASKETBALL

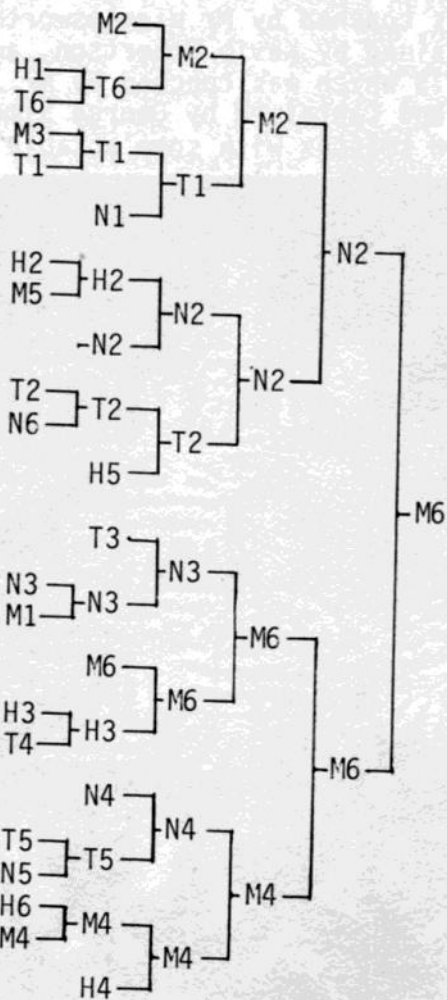
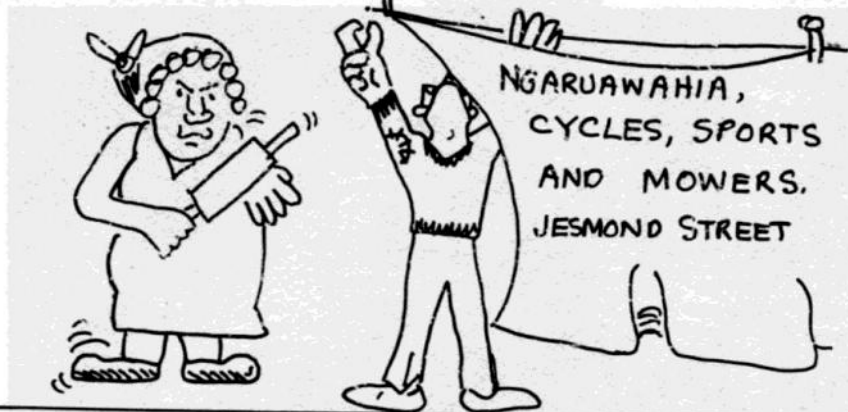
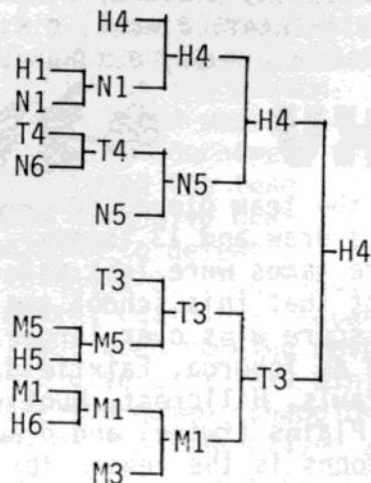

PLATE COMPETITION



violence than ever before. To punish a child or teenager, a withdrawal of privileges, such as no T.V. for a week or have the car keys taken away for a while is far more effective and everlasting than a hiding. Society has already churned out enough individuals like Mrs. Jones and Mr. Smith who know of no other ways of punishment or expression of feeling. O.K. so a lot of our parents have been victims of this form of society, what's it got to do with you or me? You are the society of the future, tomorrow's parents and decision makers. It's you who will have to change things. If there is less condoned violence there will be a decrease in illegal violence. Tomorrow is your life in a country of your own making.

Increase your awareness in the problems of society today and you are part way to improving it for tomorrow. Just remember that you only get one chance. So it's up to you.

- Belinda Hill



RUGBY

The 1981 season saw this school enter three teams in the Waikato Secondary Schools' Rugby draws. The most successful team was the Under 54kg squad coached by Mr Māns and Captained by Evan Stokes. The Under 60kg team, which was coached by Mr Wigglesworth and Captained by Kevin Robertson, and the 1st 15 which was coached by Mr Grinter and Captained by George Simon, had mixed seasons with some notable

wins and one or two losses which should have been avoided.

There was no 2nd 15 this season as a result of fewer senior school players and this is an area of much concern. All schools need a progression of teams so that players may move through the system towards the 1st 15. A gap in the progression halts this progress. It is hoped that in 1982 a viable squad of 2nd 15 players can again be assembled. Rugby in the school will be better for this.



REAR: G.Robinson, M.Simon, W.Muru, D.Timms, A.Haultain.

CENTRE: Mr Grinter, J.West, E.Nikora, Huranui Muru, B.O'Hearn, B.Sweet, Mr Murphy.

SEATED: Hekewaru Muru, J.Tahana, R.Wall, G.Simon, H.Lovell, G.Johnston, P.Lornie.

1ST XV



This season the team played 22 games for 9 wins, 1 draw and 13 losses. Although more games were lost than won, the fact that this school can continue to score wins over larger schools such as Tokoroa, Fairfield, Tamaki, St Pauls, Hillcrest, Huntly and Hauraki Plains (twice) and draw against St Johns is the reason for satisfaction and optimism.

The squad was small (Only 18 or 19 regulars) and unfortunately badly hit with injuries. Several key players missed several games with a variety of injuries. Small schools always feel the loss of a key player, and this was, at times, frustrating.

McNAMARAS
CHEMIST.



Several players stood out:



George Simon in his third season with the team was again Captain. He has played 65 games for this school's 1st XV, 43 of them as Captain - records surely.



Ross Wall was outstanding as top try-scorer and deservedly gained selection for Waikato at Under 18 level.



Hekewaru Muru was the team's top points scorer with 116 points and is a player with a great future



Joseph Tahana, in his second season at lock, gained selection in the Waikato Under 16 team and was awarded the trophy for the best Waikato player of the Under 16 Tournament.

Waata Muru, Grant Johnston, Bryce O'Hearn, Justin West and Dale Timms returned to the squad and all rate as the most valuable as well as the most improved players.

Newcomers Andrew Haultain, Jeffrey Robinson, Howard Lovell and Peter Lornie show promise and should be valuable members of the 1982 team. Huranui Muru (when available), Earl Nikora, Brian Sweet, Mark Simon, Keith Simon and Peter Rawiri also made crucial contributions to what was a happy team.

If sufficient players return next year then this year takes on the role of rebuilding and the promise of success in 1982 increases.

Thanks must go to our "tea-persons", especially Roka Davies and Maria Prendergast. Mrs Timms was a great supporter and will be missed next year. Special thanks go to the parents who provided vehicles; Mr Sergeant for his willingness to assist when needed and to Mr Murphy for his support. It is hoped the occasional win compensated for some of those "nearly won" games!

RECORD

v. Hauraki Plains	38-16
v. Fairfield	15- 8
v. Cambridge	8-19
v. Fraser	4-23
v. C.C.N.Z.	7-31
v. Hillcrest	20-14
v. Melville	19-22
v. St Johns	10-10
v. Cambridge	10-22
v. Te Awamutu	10-24
v. Waitakere	7-10
v. Hauraki Plains	10- 6
v. St Pauls	14-10
v. H.B.H.S.	4-53
v. Huntly	19-14
v. Putaruru	13-19
v. Matamata	7-20
v. Otorohanga	4-14
v. Fairfield	9-13
v. Papakura	0-12
v. Tokoroa	26-14
v. Tamaki	27- 0

Played 22 Won 8 Drawn 1 Lost 13
Points for 264 Points Against 358

- A.C.Grinter

3rd XV

The -60kg. team had a mixed season with some high scoring wins coupled with some disastrous losses. They began the season in fine style winning six of their first seven matches (averaging 22 points a match). This placed them into Division A of their grade and from here on they faced stern opposition every Saturday, with the larger Waikato schools fielding some very strong teams in this division.

However, the team learnt some valuable lessons and their basic rugby skills improved immensely. This improvement was indicated in the team's final match, (19)

a narrow 6-0 loss, against Melville, who earlier in the year gave our team their heaviest defeat of the season.

The highlight of the season was the winning of a Quadrangular Tournament held at Ngatea. In the first round the team, displaying their finest defensive qualities of the season, held on to defeat the favourites, Hauraki Plains, 4-0. The final provided an exciting match, against Te Kauwhata, with some excellent open running movements from our team, to give us a 13-9 win and the joy of being the tournament 'champions'.

All members of the team played with determination and spirit. However mention must be made of Kevin Robertson's leadership;



REAR: A. West, P. Clark, J. Bradshaw, M. Nikora, T. Hansen, G. Winchcombe, L. Turner, Mr Wigglesworth.

SEATED: G. Owens, B. Sargent, A. Collins, K. Robertson, P. Hodgkinson, R. McIntosh, J. Dufful.

Raymond Salt's 16 tries, Phillip Clark's fine Rugby skills bringing 57 points; Daniel Ruapapere's and Grant Winchcombe's improved forward play and Allen Collins forward leadership.

Overall, the "under sixties" had a grand team spirit, enjoyed their rugby and experienced the comradeship team events provide.

Played 20 : Won 10: Lost 10.



4th XV

The under 54 kg. team had a very successful season having had 12 wins from 15 games and the process scored over four hundred points.

The teams greatest asset was its team spirit and sportsmanship with the lads all working for the good of the team and not playing for personal glory. We almost always had a good turnout for practices and during the lunch hour many of the boys would take a ball and practice together.

It is very difficult to single out players as being better than others because of the large number of good players who deserve mention. However captain Evan Stokes deserves a mention for so ably leading the team both by his spirit of enthusiasm and his example during the game even when



REAR: A.Begbie, D.Lauder, S.Johnston, G.Vernall.

CENTRE: K.Morgan, R.Benny, J.Houghton, A.Evitts, S.Stratford, R.Gutry, P.Mans.

SEATED: T.Head, B.Carter, M.Collis, E.Stokes, P.McMillan, S.Wilson, D.Griffiths.

things were against us. It was a good season and as coach I would like to thank the boys for their part in making it an enjoyable season for me and the parents for their

tremendous support, which I think is the best I have ever had.

- P.A. Mans

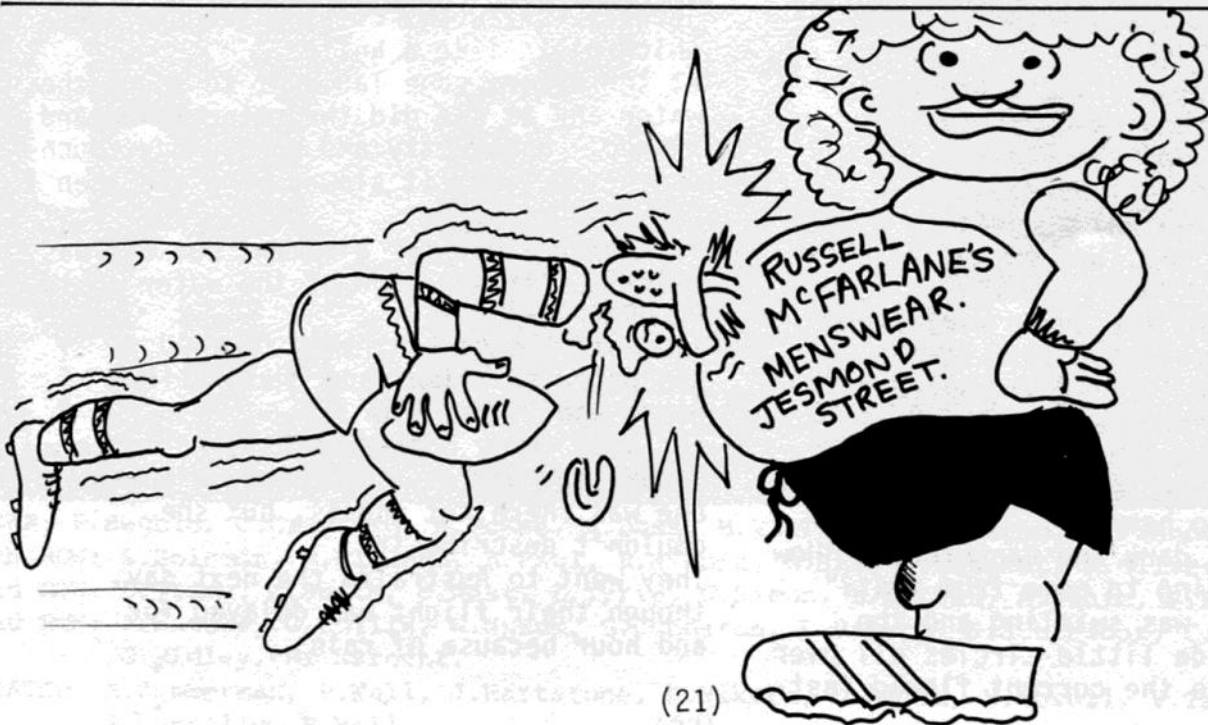

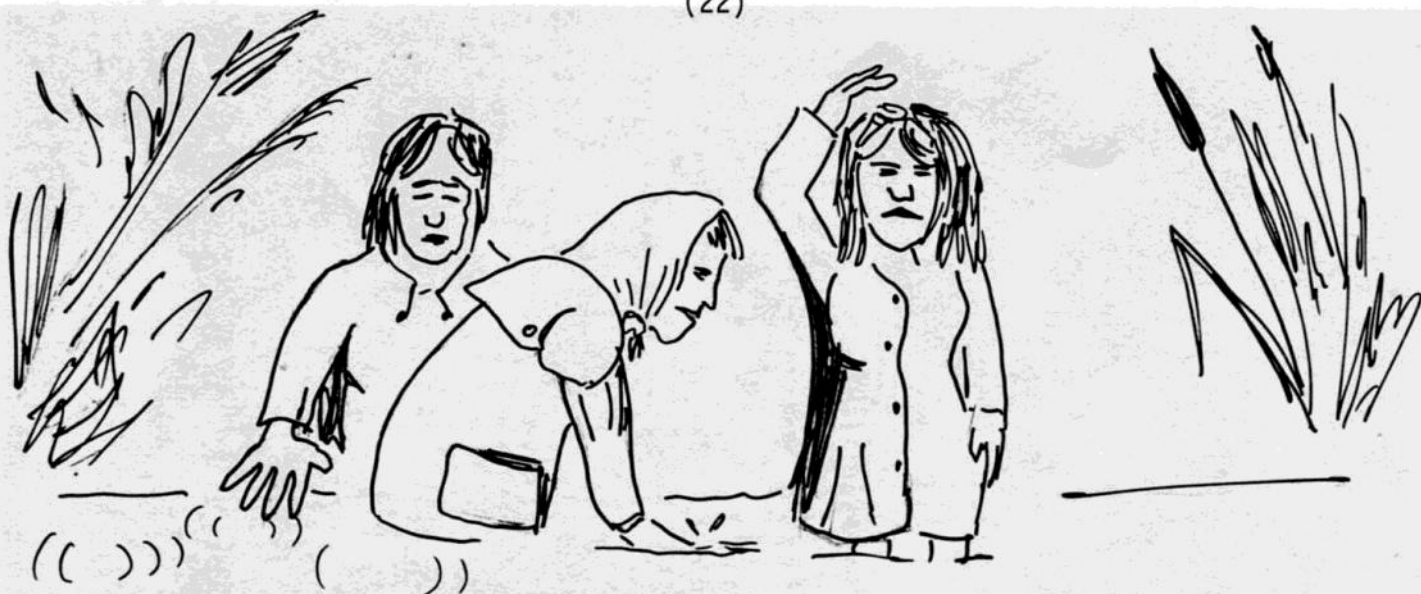

... AND THE RAIN STOPPED!

by MARAE TUKERE

"What's the time now?" Mum asked.

"Nearly a quarter to 12" I replied glancing at the clock on the window sill.

"And it's still raining" she said half to herself, half to anyone bothering to listen.

I sat in front of the fire watching t.v., "Petrocelli" or some other American garbage. It was night, the rain fell heavily, promising, puddles, mud and wet clothes tomorrow.

Mum and her friend, Betty were leaving for Australia tomorrow night but before they went, at 12 o'clock on the dot tonight, they had to go down to the river and do the water. This was an old custom for all Maoris, just a safeguard against bad-luck and troubles before any trip away from home.

"Gee, I hope it stops" she muttered. She left to go and pick up Betty and my Auntie Jim, one of the old kura of the pa, who would recite the appropriate karakia (church) so getting rid of any evil that may lurk on the flight over the ocean.

At about 10 to 12, the three went down to the pa and parked as close to the river as possible. It still rained heavily, lightning flashed, thunder rolled and all the other spooky things that just had to happen tonight, my mother thought to herself.

The river looked dark and dangerous. "How was good luck going to come from that?" she thought. It was swirling and the drops of hail made little circles all over the rough surface the current flowed fast-

er than ever.

"Lucky I bought a raincoat", Betty said at five to 12, when the rain still fell, as heavily as ever.

"Aue, what a night," Tau said, "And I forgot to turn my flashæw electric blanket on. Never mind, just have to get the old, pakaru hot water bottle out". Mum laughed and they grew silent again, dreading going out into the rain, yet knowing they had to. It was 1 minute to 12, when Tau said "Come on we better go now".

They got out of the warm car and gingerly poked their way down to the river. The hail and water hit them with all the force of a gail. Wind whipped the coats and jac jackets they wore, cutting through the thick cloth like a knife.

At the waters edge Tau bent to touch the water and as she did the rain slowed and slowed. When Betty and mums hands touched the surface, it slowed more and then the rain stopped.

The three stood for a moment but all was quiet. Only the flow of the water could be heard.

Tau said the church, they touched the water six times and tier their heads and it was over.

"It was, in my mother words", not spooky but we felt something or someone was there not ghosts, but she couldn't describe it.

They went to Australia the next day, though their flight was delayed for an hour because of rain.

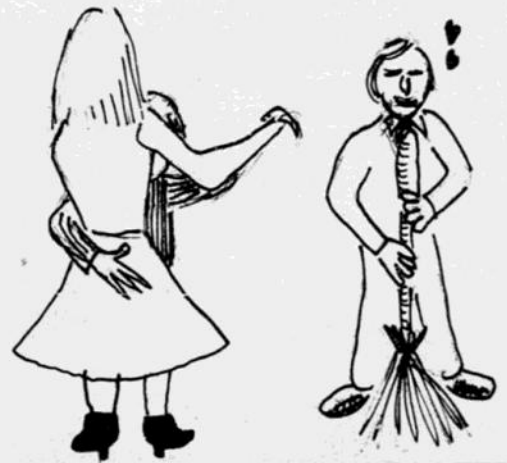
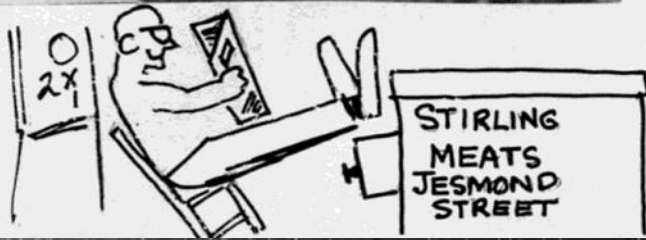
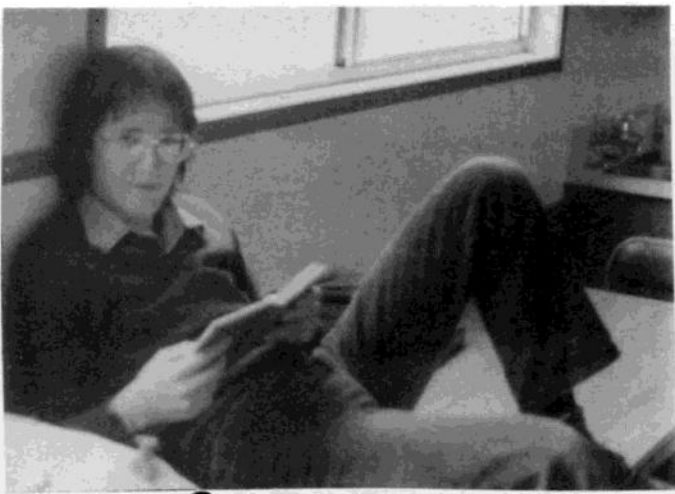

REAR: P.Begbie, C.Crawford, K.McKee, S.Dass, M.VanTiel, N.Preston, M.Prendergast.
 4th ROW: S.Solomon, B.Cleland, A.Paul, R.Nikora, D.Sam, D.Barakat, R.Oliver, S.Puncheon.
 3rd ROW: D.Timms, W.Smith, J.West, L.Tyrie, G.Simon, L.McLean, A.Sahib, L.Park, G.Wood.
 2nd ROW: J.Waters, G.Collis, W.Nuzum, G.Johnston, L.Harrop, S.Schreiber, C.Haggie,
 G.Ridley, Mr Sargent.
 SEATED: A.Zimmerman, R.Wall, J.Hartstone, E.Nikora, S.Smith, H.Lovell, V.Taylor,
 R.Connolly, R.Bell.

library



Mr Keo Muru and his son Waata stand beneath their work in the new Library foyer.

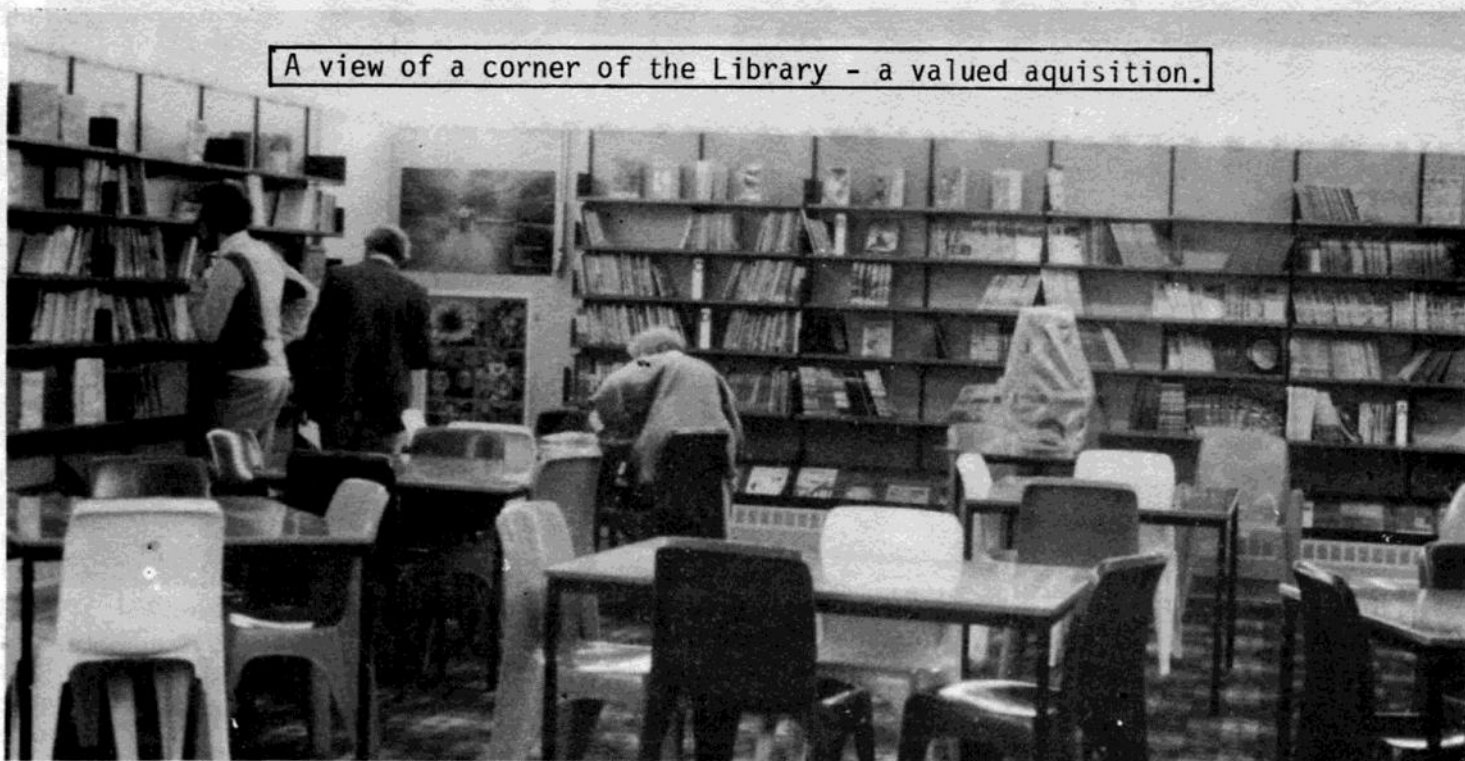

A view of a corner of the Library - a valued acquisition.

Ngaruawahia historian Mr Bert Latta on the steps of the Sir Douglas Carter Library just before the official party makes their inspection following the opening ceremony.



Sir Douglas Carter, Mrs Birch and the Honourable Bill Birch at the Luncheon following the opening of the Library.

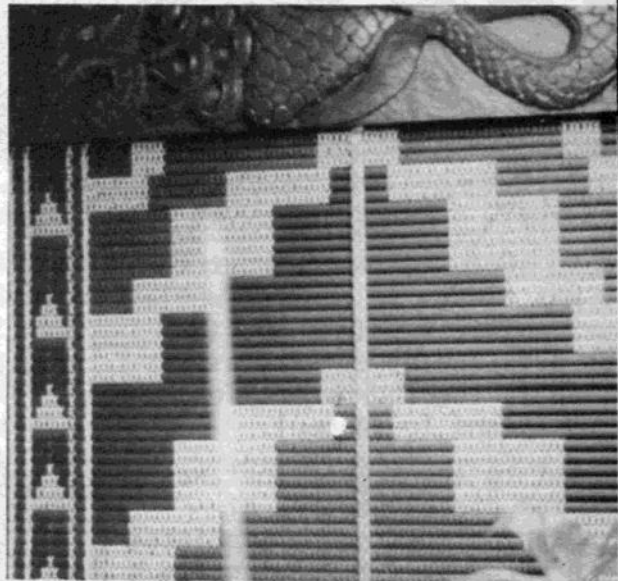

A section of one of the tukutuku panels flanking the main doors to the Library. The panels were made by members of the Maori Studies classes of the school under the direction of Mrs Huia Dixon.

THE NEW LIBRARY BUILDING WAS OPENED ON SEPTEMBER 25th 1981 BY SIR DOUGLAS CARTER K.C.M.G. IN THE PRESENCE OF THE HONOURABLE W.F.BIRCH M.P. MINISTER OF ENERGY AND BEFORE A LARGE GATHERING OF VISITORS, STAFF AND STUDENTS, AS WELL AS BOARD OF GOVERNOR MEMBERS. FOUNDATION PRINCIPAL E.B.ALISON AND MISS V.JOLLY WERE ALSO PRESENT AT THE CEREMONY IN THE SCHOOL HALL.

BASKETBALL

(26) their games, the acquitted themselves well in the closely contested Premier Grade of the Hamilton Schools' Competition. With most of the players planning to return in 1982, the future looks bright.

This years team consisted of a number of young, promising players, mixed with two or three of the old hands. Although the team won only just over half of the



REAR: S. Paul, T. Rakena, Mr Meadowcroft, A. Paul, J. Heremaia.

SEATED: L. Turner, B. Sweet, Hekewaru Muru, J. Tahana, Huranui Muru, B. Williams, P. Williams

Hekewaru Muru shot well throughout the season and was always in control while on the court. His 257 points for the year was an outstanding effort, as was his selection in the Tournament Team at the North Island Tournament.

Also important to the team effort was the defense and close shooting of Captain Joe Tahana to score 170 points; the strength of Hurunui Muru with his 180 rebounds; the experience and steadiness of Arthur Paul; and the competitive drive of Peter Rawiri. Others to show promise during the season were

Peter Williams, Bouffy Paul and Tatua Rakena. Bryan Sweet's arrival from Singapore towards the end of the season proved a great boost to the team and helped compensate for the disappointment of losing Brandon Williams through injury earlier. Others to appear for the team included Josep Heremaia, Korona Morgan and Lincoln Turner. These boys have been a loyal and dedicated bunch, and always approached the game with plenty of enthusiasm. They can look forward to an even better year in 1982.

Cambridge	won	28-19	Fraser	won	50-20	Church College	lost	30-32
St Johns	won	50-24	Huntly	won	57-22	Papakura	lost	28-42
Hillcrest	won	17-12	Melville	lost	8-14	Fraser	won	71-48
Fraser	lost	48-64	Church College	lost	47-57	Te Puke	won	47-43)
Fraser	lost	29-30	Fraser	won	65-44	Rangitoto	lost	48-68)
Melville	won	47-27	Melville	lost	25-28	St Kentigens	lost	44-59)
St Johns	won	67-47	Hauraki Plains	won	34-25	Cambridge	won	74-22)
Church College	lost	49-54				Gisborne Boys	lost	42-57)

N.I.
Tourn.



REAR: C.Henare, T.White, T.Gray, W.Tairakena, K.Herangi, Mr Paurini.
 SEATED: F.McCarthy, W.Sweet, A.Paekau, D.Stephens, C.Paekau, T.Tipene, R.McIntosh.

This boys' team (and what a team it is) did very well this season. We were beaten only twice at the hands of Church College of New Zealand, and finished second in the Hamilton Competition.

The squad had 11 outstanding players who attended early morning practices to improve their skills. Thanks go to Mr Paurini for all the time he put in by teaching us some of his vast

knowledge of basketball. Parents must also be thanked for their support.

In the Hamilton Competition we played ten matches and won eight. In the inter-school matches we won as follows:

v. Hillcrest	37-8
v. Huntly	36-4
v. Papakura	56-0

Tony Paekau

VALEDICTORY

1977 saw the arrival of an enthusiastic young man in the shape and form of Tim Meadowcroft. He had come, ostensibly, to teach Economics, English, Integrated Studies and Mathematics, but ended up leaving his greatest mark with the students on the Basketball Court.

Trained at Canterbury University he was well qualified in his continual strivings to reach the top of the Staff Pool Ladder and in being an integral part of all and any Staff/Student sports meet.



He is off north to St John's College in Auckland where he will train for the Anglican ministry for 2 to 3 years. His five years amongst the pupils and staff of Ngaruawahia High School should give him good grounding in patience!!!

Tim has found Ngaruawahia a good place in which to live with the kids very amenable in the classroom. He will be living in Meadowbank (coincidental?) and we regret the loss of a teacher of the calibre of Tim Meadowcroft and wish him luck in his chosen field of endeavour.



REAR: C. McRoberts, J. Rakena, R. White, A. Paurini
 SEATED: M. Clay, M. Kaio, B. Matenga.

The team improved markedly this year, showing excellent play in the Hamilton Competition. They finished a well-deserved 2nd with a seven win and 2 loss record.

The players show the ability that will lead them to school Premier Team representation in future years.

Interschool Matches:

- v. Hillcrest 10-5
- v. Huntly College 22-8
- v. Papakura 28-24

SOMETHING?

I don't normally write about something so this time I will. Although something could be anything so therefore if I was writing on anything then I would still be writing on something. If something was someone, anyone or nothing, then I could write about anyone and still it would be something and that goes the same for someone or nothing so that means that someone could be nothing and that could be anyone, and it would still end up to be something.

- Mia Simon 3.3



REAR: M. Simon, M. Simeon, R. Kirkwood, Mr Paurini.

SEATED: A. Jacobs, N. Henare, T. Tai.

The squad had an excellent season with the loss of only one game. This performance placed them second in the league, and their play reflected the long long and early hours practicing in the school gymnasium.

Credit must also go to the parents who supported the team and to their coach, Mr Paurini.

Interschool Results:

- v. Papakura 20-8
- v. Hillcrest 18-4

Premier Girls BB

The team had an excellent season, displaying an abundance of natural talent teamed with hard work and top coaching by Mr Paurini. By winning 7 games out of 10 the team was placed 2nd in the Premier Grade of the Hamilton Competition.

The squad worked hard towards the successful trip to Tauranga to compete in the Regional Basketball Championships. Twice a week they met for early-morning practice sessions, and organised a 12-hour basketball marathon that provided the teams with tracksuits.

Senior girls BB

This team was formed for the girls who also play netball for the school, to give them the opportunity for basketball at the Thursday night competitions.

About half the team had never played basketball before, but what they lacked in experience they made up for in dedication and enthusiasm.

Two mornings a week at 7am they practiced in the school gymnasium with the Premier Girls Team under Mr Paurini's much appreciated coaching. The result was a gratifying high standard of play that ended up with the team gaining 3rd place with only 2 losses out of 9 games.

The team was a steady back-up to the Premier Girls in inter-school sports visits with the highlight of the year being attendance at the Regional Basketball Championships in Tauranga.

N.I. S.S. BASKETBALL

On Sunday 23rd August eleven young men and one young adult boarded a mini-bus and set off for the North Island Secondary Schools Basketball Tournament in Gisborne to compete against five other schools.

The trip down was very exciting for us all and included all the usual stops - lunch, rest rooms, snacks, toilets, food, etc. We duly arrive at about 6pm and were met by Mr Ngarimu who hosted our first night in the town. He escorted us to the Poho-O-Rawiri Marae, our home for the duration of the Tournament.

We had a light practice that night in the Gisborne Girls High School Gymnasium where Mr Ngarimu is a coach and returned to the Marae to sleep off an enjoyable day.

Monday saw the start of the Tournament with a game at 1:30pm against Te Puke H.S. which we won - a morale boosting start. The remaining four matches were held over the next two days and proved to be very exciting.

Our night-life activities were limited, but we managed to occupy ourselves until it was time to sleep. Monday & Tuesday nights were spent at the movies. One night we got back and staged our own mini-talent quest that happened to wake up the others!

4A Girls BB

This squad finished 4th in their Hamilton Competition with five wins and three losses. The team comprised Pura Harper as Captain with Aue Jacobs, Mero Ransfield, Mutu Turner, Pauline Tahu and Wiri Haunui.

Interschool Matches:

v. Hillcrest 38-2
v. Papakura 16-20



REAR: J.Rawiri, S.Wilson, S.Whaanga.
SEATED: I.Gambrill, S.Cocup, D.Holland.

We were happy with our 4th placing and the success of our participation was in having Hekewaru Muru selected in the Tournament Team. This squad played the Gisborne Mens' Rep Team at the end of the Tournament.

All the players thoroughly enjoyed themselves mainly due to the support of all the parents and friends that assisted us in getting to the Tournament. Mr Meadowcroft, who proxied for our mother, chaffeur, treasurer, coach and friend, must be the key man to whom most of our gratitude must be directed.



THE SUN

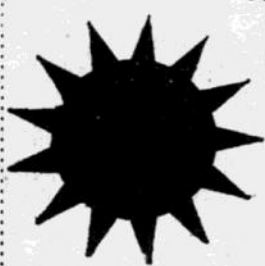

\$4.50

No. 22,915

WEDNESDAY, SEPTEMBER 16, 2001

CITY

SUPER VALUE

MIDNIGHT FLIGHT

Dale Barakat arrived at Ngaruawahia International Airport and departed via Pirongia Airline's Mumbo Jumbo Jet amidst the cheers and applause of thousands of fans.

Miss Barakat has just won the Inter-Galactic



'HIGH' PROFITS

The "New Zealand Pot Company" released officially that they have cabbages, loobarb and

title of Miss Hopper 2000. When asked how she managed to cover the intersatellite distance in a record time of 5 macro melentens she replied, "I owe it all to my Johnny Walker Juice".

BUSINESS HOTS UP

Contractors ready

The extension is to be situated in Orini and will be called "The Orini Hilton". The Hotel will be a popular tourist spot, overlooking the scenic beauty of the murky Man gawara Stream with its unique attraction of bloated cows. Sir Johnston believed this



An extension of the "Johnston Brewery Co-op" was announced today by Managing Director Sir Grant Johnston.

Forecast: In the North mainly cloudy in the west with drizzle patches night and in the east, apart from a fine in Gisborne. In the south will be areas of misty rain. Coast and occasional showers in Southland and Marlborough and Canterbury mainly fine, though cloudy.

BEEHIVE MOVES NORTH

Beehive Building will be shifted from its present site Wellington to the rapidly expanding city of Glen Massey. He said the decision to shift the Beehive was one of the most crucial and toughest decisions he had ever made in his entire political career (of two weeks). This follows the P.M.'s previous decision to have the statue of the late Prime Minister Muldoon, sited outside the Hutton factory.



At a press conference today, Prime Minister the R.H. Dale Timms confirmed that the

Court in brew

...als, was caught by police attempting to carve the words "W.M. was here" into the wall of the Ngaruawahia Opera House. The Judge asked Muri the reason why he acted in such a foolish manner, and thus tarnishing his hard-earned reputation. Replied Muri: "I just got the urge..."

Master Carver, WAATA MURU, today pleaded guilty in the Ngaruawahia District Court, to a charge of being drunk and disorderly in a public place. The Court heard how Muri, a distinguished Maori carver with the local High School Library foyer to his long list of cred-



The fast food chains of the late 1980's are not all dead. "Sahib's Curry Pot" was today opened on the corner of Jesmond Street and The Great South Rd, opposite the Ngaruawahia Opera House. Owner, Mr Ahmed Sahib, told reporters that his Curry, Rice & Synthetic Plow was aimed at Robots and Androids as it was not fit for Human consumption.

Human consumption.

SPORT

Maria Prendergast began waterpolo coaching sessions at the N.H.S. indoor Olympic Pool this week. Maria has successfully combined both interests prominent in her early days at Ngaruawahia, netball and swimming, and is currently National Men's Coach. Ms Prendergast conducts daily clinics at Orini, Horotiu and Tangirau.

Dr Tyrie told us she between her toes for some 15 years. Dr Tyrie also told reporters that her success had been no mean feat.

PERSONAL

IS THERE A LONELY FEMALE

Care to join a lonely male, Auckland trip next weekend, view to, **CRISTINA**

...to my previous product, when in 1985 its use was finally legalized." It is obvious that Mr Sam made the right choice, as is verified by the ten Fu Man Chu tractors parked in his extensive network of green-house complexes. We left Mr Sam on a very high note, saying, "KEEP NEW ZEALAND GLEEN!"

TYRIE TRIUMPHS



A breakthrough in Bacterial Warfare was announced by Dr Leanne Tyrie - (M.D.), Ph.D., Dip.Ob., M.Ch.B., M.F.R.C.S., D.H.G.81, Va.In., Head of the Ellery Street Academy of Medicine. The bacteria is believed to be the most deadly organism on earth. The discovery was made as Dr Tyrie set about washing her feet. The new organism is known as "LEANNIS BACTERIUS JOEJAMMIS."

...a record profit of 30,000,000 credits at the end of this financial year. Speaking to reporters

ATIONS
9 a.m.

Today
Prty cldy
1019mb
13.9°
88%
Sz SW mod brz
am.

FOLK FACE FEARS



Dr SHANE SOLOMON was in Ngaruawahia today to address the local Branch of the Committee to Revive the Protectors. Solomon is to assist Gerry Attrick (local newspaper) in sound preparation of suitable and effective methods for Ngaruawahia C.R.A.

Teacher ready to strike

NITPICKERS' KNUCKLED



TERRO

It was reported that Professor Van Tiel, the fireworks runner in the early 1980's, notorious Nuke runner in the late 1990's, was arrested somewhere near Lake "D".

Following the release of his "Verdict" on the use of missiles, VI, VII, VIII, Prof. Van Tiel created in his laboratories the most devastating weapon on earth - the V.D.

The "Verdict 500" is reputed by Professor to have the power of 10 pineapples, 18 prunes, 45 Kinas all eaten by the same person. Van Tiel was arrested while trying to use the weapon to repatriate natives of "3rd world powers." Commenting from his cell, Professor said, "The Bomb had the potential to start many movements. I had a chance and I blew



Principal of Te Kowhai Technical Institute, Miss Judith Hartstone (M.A.), today publicly condemned the present education system.

"How are computers supposed to be able to teach to full capacity under such adverse and inadequate conditions" she bled to reporters. "A grease and oil once a week! They are only human too, you know!"

At this point red flames shot from Miss Hartstone's (M.A.) head as her left antennae short circuited in a brilliant display of pyrotechnics!

The gang confrontation that flared up late Friday night is believed to be the result of provocative action undertaken by Racheal "Notorious" Nikora, infamous leader of the Horotiu Mongrel Mob. Wielding a soccer ball, Miss Nikora charged down the Main Street, clad in her multi-coloured leather jumpsuit yelling abuse at the rival gang and taunting them on her nifty fifty. Screeching her scooter to a halt, Miss Nikora dismounted from the mighty machine and began kicking the ankles of the now-riled Netherby Nitpickers, a technique she perfected whilst playing soccer in the early 1980's.



BLOW TO RUGBY

Following the ugly scenes at the Taupiri stadium, where All-Black Captain George Simon threw a tantrum in the middle of the field after referee Ray Budgen Jnr. gave the opposition a penalty with which they won the game, Simon (36) announced his retirement, thus ending a monumental chapter in New Zealand Rugby history.

Representing his country in International games, George has to his credit, the Grandslam Tours of United Kingdom (1997), Zimbabwe (1998) and Antarctica (1999), 18 pints at the Waipa, 5 dozen at the Delta, 50 tries (to change the ref's decision) and the reputation of the most outspoken Captain in the world.

Commenting about his career Simon had this to say, "Oh Ref, Ref, penalty Ref, Ref! That was out 'Oh Ref, Ref!'". (32)



(33) the type of person who will throw herself into a pool in a flurry of arms and legs, to help her house to victory; and wear an old gym frock on mufti day to get into the "hang" of things. Many a staff-member will recall the day she wore black tights into the staff-room, and many male teachers are still nursing egos that suffered unmercifully under the skill of "Snooker Schaare" as she shot her way to the top of the Pool ladder (if only briefly).

Whilst in this great establishment she brought life and colour (predominantly red) into French, German, English and Social Studies classes.

Mrs Schaare is leaving for Nottingham, a decision greatly influenced by her love for archery and her vital involvement in the production of "ROBYN".

Joining in protests, tramping over Waiheke Island with a band of wild 4th formers, and leading her "B" hockey squad to ultimate victory are but three of this woman's many feats. What the red headed male is reputed to have in temper, Mrs Schaare has in wit, charm and personality. We wish her well and the best of luck in her new endeavour overseas where she INSISTS she will not teach!

VALEDICTORY

Describing herself as a late bloomer, Mrs Schaare joined us in 1980, a year in which she did little to bring attention to herself, although helping significantly in the production of the school play.

This year we observed the Mrs Schaare we have all come to know and respect. She is

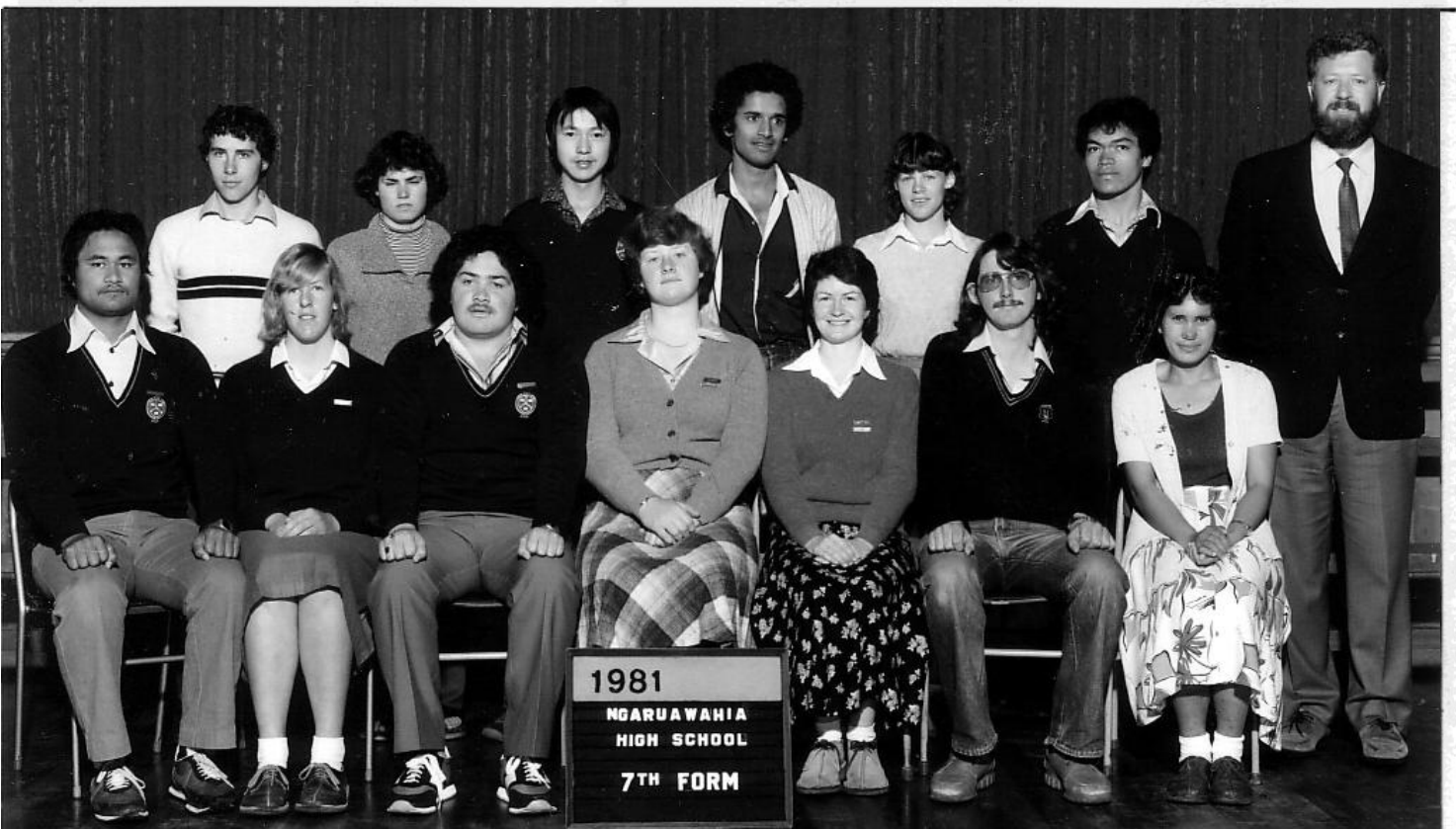

REAR: M. Van Tiel, D. Barakat, D. Sam, A. Sahib, M. Prendergast, S. Solomon, J. Sergeant.
 SEATED: G. Simon, S. Smith, D. Timms, J. Hartstone, L. Tyrie, G. Johnstone, R. Nikora.

GIRLS HOCKEY (34)

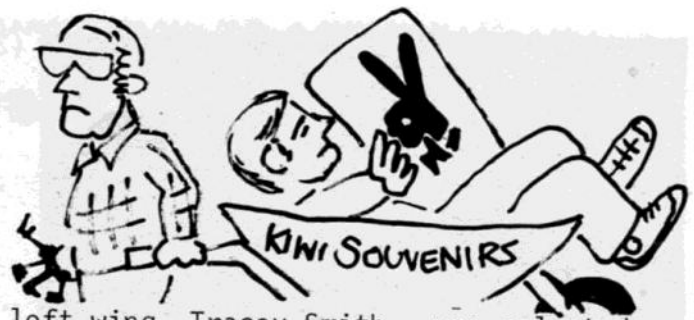

'A' Squad

Its hard to believe that yet another year has passed by in what seems like a very short time. The season started with a few unfortunate mishaps which we were able to smooth out within no time. Due to the numbers of girls, two squads of 14-16 girls each were formed and as the season drew on this choice proved to be fortunate as injuries claimed many of the girls for periods of up to 2 months.

Fortunately we were able to hold out last year's grading in section four, and the competition proved to be a good challenge for the squad. As the season progressed many of our players' games improved to the extent where no girl was any better or worse than another.

Our left wing, Tracey Smith - was selected to represent the school in one of the Waikato Secondary School Girls' teams. She represented the school well in the games she played, however the weather did turn for the worse on some occasions, causing her to take to the sideline for a few weekends due to illness.

The team was coached by Mrs B. McLean who did a tremendous job, considering she knew little about rules of the game and coaching. Nevertheless without her constant support and devoted hours spent at practices the team would not have been able to see the season through.

- L. McLean



REAR: Mrs McLean, H. McLean, Mrs Curtis.

CENTRE: Mrs Schaare, J. Capper, L. Hanes, S. Fisher, T. Smith, H. Johnston, K. Stirling, Mr Samujh.

SEATED: G. Runciman, L. Park, W. Nuzum, L. McLean, V. Taylor, M. Tyrie, D. Turton.



REAR: K.Rogers, L.Rogers, M.Curtis, D.Renete, K.Singh.
 CENTRE: J.Schaare, F.Crowther, S.Acherman, J.Plummer, L.Harrop, K.Perham, P.Samujh.
 SEATED: S.Frangos, A.Baird, D.Collins, B.Cleland, J.Frankhouser, W.Zimmerman, T.Abbot.

B TEAM

At the start of the hockey competition at Innes Common in Hamilton, the B squad was competing in Grade six. It was consistently in first place, and when grades 5,6, and 7 were rearranged after seven weeks, the B squad was promoted to Grade 5.

The B squad won the President's Trophy for Grade 6, conceding only 5 goals to 39 gained, and in grade 5 came runner up to Dro B. The Squad were defeated only once during the season.

All the girls have worked hard and given their best to the team. Jan Plummer, the vice captain, both on and off the field, has been a tremendous help to the team. Our coaches have been a great help. They willingly gave up their own time, during school and weekends to support and coach us. Special thanks is due to Mrs J. Schaare for her tremendous support throughout the season.

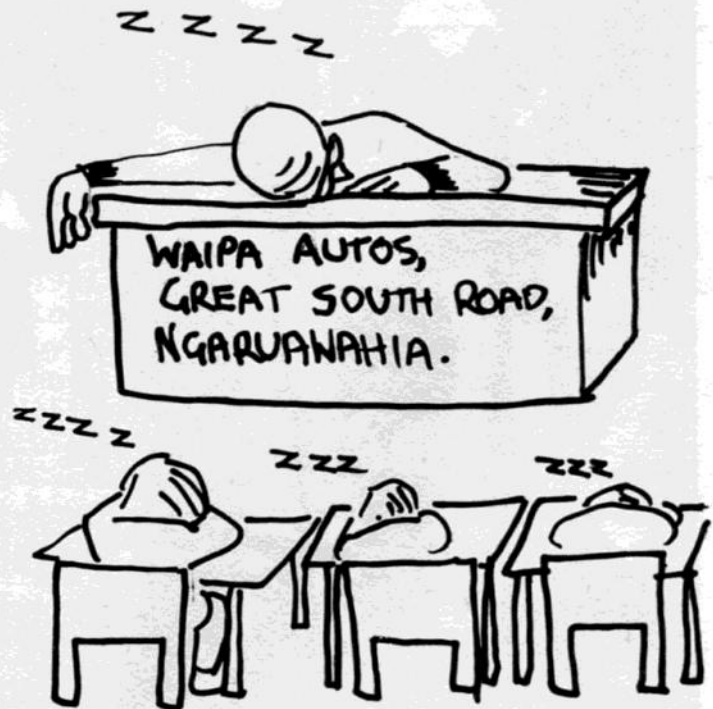



BOYS HOCKEY

The Girls' hockey coaching team is sorry to farewell Mrs Mary-Ann Curtis who coped so ably with coaching and administrative responsibilities during her time at the high school. The girls and coaches honoured her with a luncheon and presentation just prior to her departure. We are very grateful to Mrs Curtis for her valuable contribution to the sport in this school.

As far as the coaching of the 'B' Squad is concerned, I gratefully acknowledge the assistance of Mr Puran Samujh whose knowledge of the sport surpassed my own and aided considerably in the strengthening of team tactics and skills.

My thanks to the girls who made the task of chief team supporter masquerading as coach so enjoyable.

- Jillene Schaare
('B' Squad Coach)

At the end of this season the boys ended up with an excellent set of results. This could not have been achieved without the persistence and skilled coaching of Gerry Clark. His hard work and help was much appreciated.

Every member of the squad was dedicated to training and gave 100% effort in each match. Parental support was received at some games and our special thanks to Mrs Clark, Mr Holden, Mrs Frangos, Mrs McLaren, Mr & Mrs Schreiber, Mrs Stevens and Mrs Wood. Much-needed transport was provided by them as well as frequently strained vocal chords.

Our success was attributable to several key combinations and the brilliant saves from goalie Matthew Stevens. Backs Kevin Hooker and Andrew Holden performed excellently when stopping any threatening attackers. Centre-half Raymond Connolly supported well and was in turn supported by fellow-halves Kerry Stirling, Stephen Rowe and Stuart Mackrell.

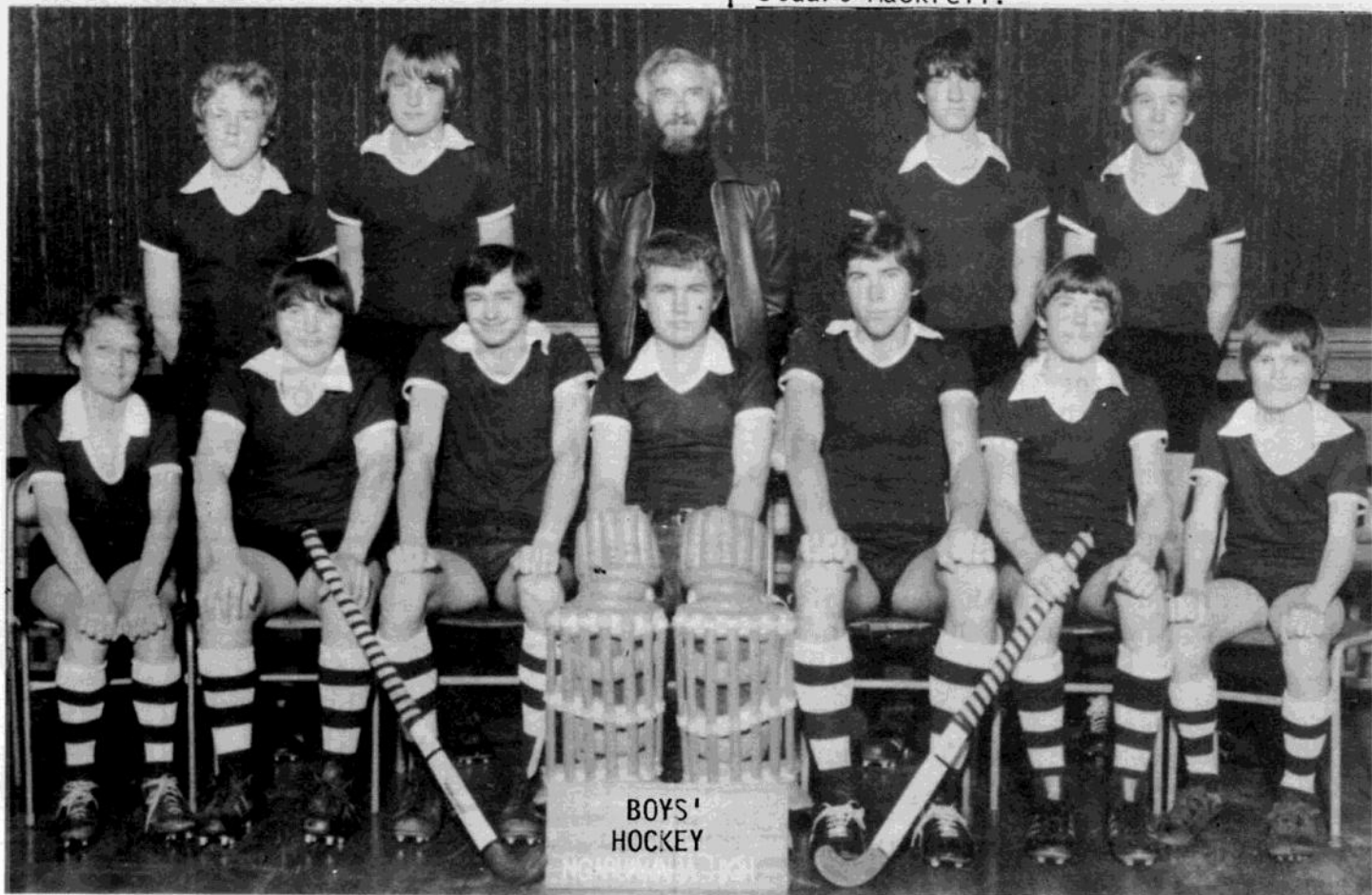

REAR: M.Tournier, A.Holden, G.Clark, S.Schreiber, S.McLaren.
SEATED: S.Mackrell, K.Hooker, G.Wood, M.Stevens, R.Connolly, P.Frangos, K.Stirling.

The fast and sometimes fiery forward line created havoc for the opposition backs. Wingers Scott Schreiber and Michael Tournier split defenses and sent in Gary Wood for the final touch. Inside forwards Stephen McLaren and Paul Frangos provided speedy and sound backing for all. Utility player Chris Herdman filled the gaps in the team admirably.

The biggest loss of the season was to Hamilton Boys High School by seven goals to nil. We never looked like taking out a victory but played what we considered was one of our best games of the year against the strongest 3rd Grade team in the Waikato.

Our most stunning victory was that against Church College of N.Z. 8-3. The final day of the season proved the most successful. In a Round Robin Tournament we defeated the other five teams in our competition to win the CLARK PLAQUE, kindly donated by Mr Gerry Clark and the 1st XI to the Hamilton Hockey Association.



**NGARUAWAHIA
BURGER BAR LIMITED
GREAT SOUTH ROAD.**

RICHARD WIGELSWORTH entered Ngaruawahia High in 1978 to the delight of many of the senior girls, who practically drooled at the mouth every time they saw him!

This was his first school and he was overwhelmed at the friendly reception he received and at the harmony apparent between staff and students.

"The funniest thing that has happened to me at this school," Wiggy recalls, was when I was faced with my new Group room (H.4). Unaware of what was expected, I asked one of the students (Joe Tahana) to help me take care of the third-formers. I was shocked, and just had to laugh when Joe said (in that distinctive BIG JOE voice), 'But, Ah, Sir. I am a third-former'.

Throughout his four years here Mr

The three main highlights were:

- A 24-hour Hockey-thon.
- A mixed team thrashing the staff 3-1,
- A tour to Rotorua, Tokoroa, Taupo, the Chateau and Taumaranui.

I enjoyed Captaining a side that showed endless enthusiasm and had a great deal of fun.

RECORD:

Played 21, won 7, Lost 10, Drew 4.

3rd Grade		Tournament	
v. C.C.N.Z.	2-3	v. Fairfield	2-1
v. Fairfield	1-1	v. St Pauls	2-1
v. H.B.H.S.	0-7	v. Cambridge	2-1
v. Hillcrest	1-7	v. Hillcrest	1-0
v. St Pauls	1-3	v. H.B.H.S.	1-0
v. Fraser	0-1	"Tour"	
v. St Johns	2-3	v. Rotorua Boys	0-5
v. C.C.N.Z.	8-3	v. Tokoroa	1-1

4th Grade			
v. ST Pauls	6-5	v. Tarua	4-0
v. Cambridge	5-3	v. Taumaranui	1-2

Interschool		Scorers	
v. Tamaki	2-1	Wood 23, Schreiber 10,	
v. Air Force	3-2	Connolly 8, Tournier	
v. Tamaki	2-2	2, Stirling 3, Smith	
v. Papakura	1-2	1. 47 for 58 against.	
v. Hillcrest	1-0		

VALEDICTORY

Wigelsworth has enjoyed a great number of activities; like trips to Waiheke, Taupo, and especially to Te Teko in 1979. Most memorable would be his trip to Whangamata where he was accompanied by some of the school's former seniors. He is pleased to see the numerous changes in the school system, particularly with the birth of the Student Council, as he believes students DON'T have enough SAY in what concerns them. Wiggy's close relationship with the sen seniors has found opens up directness. "If they don't like my lessons, believe me, they'll tell me!"

It is now time to move on and has found the ideal location in that of Mount Maunganui. However it is roundly suspected in the school that he is really going for the sun and surf rather than the teaching!

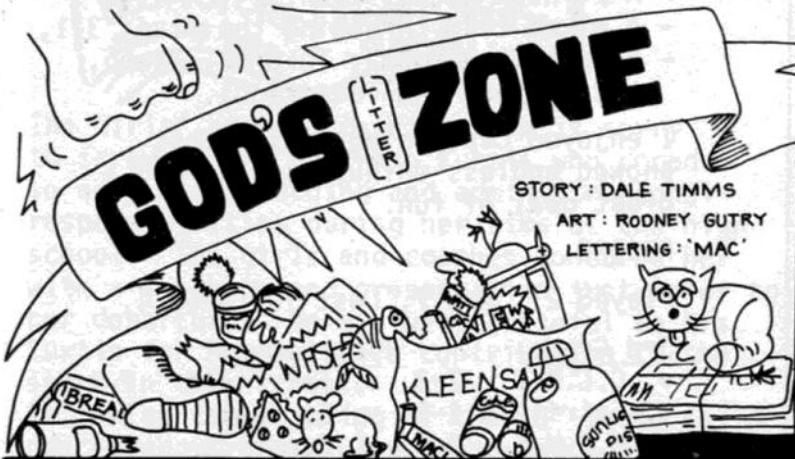

NEW ZEALAND.....
AOTEAROA..... THE
LAND OF LONG
WHITE
CLOUD..

GODZONE..... WHAT-
EVER YOU WISH TO
CALL IT! THAT'S
WHERE WE LIVE.
A SUB-TROPICAL
PARADISE
INHABITED BY A
PEOPLE WHO WILL
UNITE, AND RALLY
TOGETHER TO VOICE
THEIR DISAPPROVAL
OF MAJOR POLLUTION,
SUCH AS HUGE
FACTORIES, AS WELL
AS DEODORANTS
RUINING OUR SKIES.

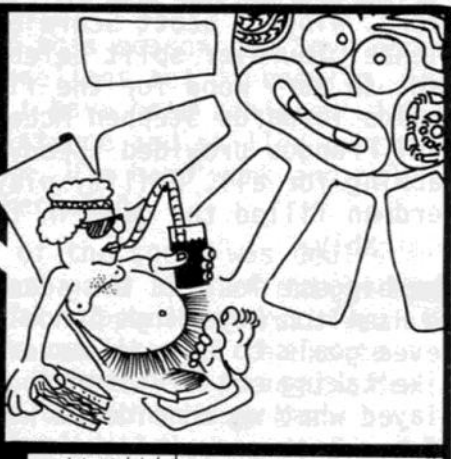

WE ARE PEOPLE WHO WILL POUNCE
UNMERCIFULLY ON NUCLEAR POWER
AND THE INADEQUATE AND DEADLY
DISPOSAL OF IT'S WASTE PRODUCTS
PEOPLE WHO WILL FORM
PICKET LINES AND PROTEST
GROUPS WHEN GOLD MINING
THREATENS TO ERODE AND UNDER-
MINE THE ENVIRONMENT - THE
COUNTRY-SIDE OF THAMES, FOR
INSTANCE.
**YES! WE HAVE ALL THESE
ADMIRABLE ATTRIBUTES TO OUR
CREDIT....**

...AS N.Z. IS A RELATIVELY
LITTER-FREE COUNTRY. MIND
YOU, WE ONLY HAVE A
POPULATION OF 3,000,000. I
SHUDDER TO THINK WHAT
WOULD HAPPEN IF OUR
POPULATION WERE 30,000,000!
WOULD WE DECLINE INTO A
STATE SIMILAR TO THAT OF
INDIA, EGYPT AND JAMAICA
WHERE THE LITTER PROBLEM
IS SO BAD THAT IF THE
BREEZE COMES UP SO TOO
DOES A TORRENT OF TRASH!



... BUT WHEN IT COMES TO
THE POLLUTION ON OUR DOOR-
STEP, NAMELY LITTER, NEW
ZEALANDERS HAVE ONE OF THE
MOST APALLING AND
APATHETIC ATTITUDES IN THE
WORLD!

WITH THE INNOVATION OF CONFECTIONARY LINES,
SUCH AS TWISTIES, RASHUNS, PINKIES, INDIVIDUALLY
WRAPPED TWINKIES,
FREEDENT GUM THAT WON'T STICK
TO MY DENTURES....

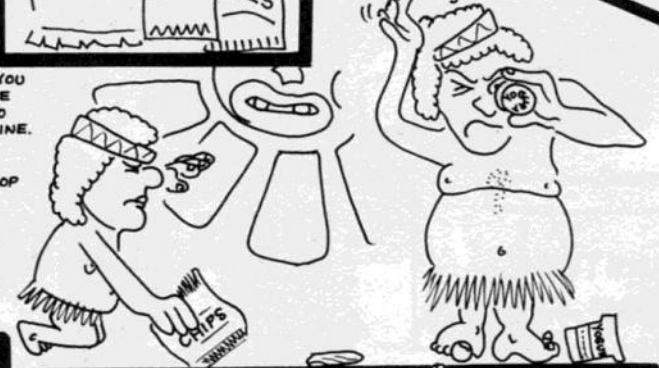

PERHAPS THIS IS A BIT TOO
STRONG.....

WHEN GOING ON A TRIP IN N.Z., YOU
DON'T NEED A MAP TO FIND THE
LOCAL DAIRY - ALL YOU HAVE TO
DO IS TO FOLLOW THE LITTER LINE.

EMPTY PACKETS OF CHIPS AND
TWISTIES SIGNIFY THAT THE SHOP
IS 10 MINUTES AWAY....

ICE-BLOCK STICKS, EMPTY
YOGHURT CONTAINERS - 5
MINUTES....

PIE WRAPPERS, PAPER BAGS -
1 MINUTE....

SO WHAT TYPE OF PEOPLE LITTER?

THEN THERE IS THE THINKER,
THAT'S THE TYPE OF PERSON
WHO READS THE MESSAGE ON
THE SIDE OF THE PACKAGE -
"DO NOT LITTER" - THINKS
"HMMM, THAT'S NOT A BAD
IDEA." AS HE CHUCKS IT OVER
HIS SHOULDER!

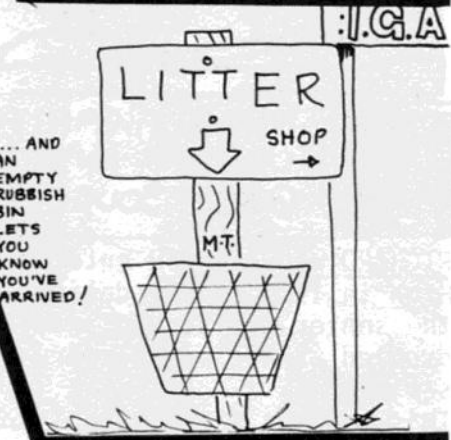

.... AND
AN
EMPTY
RUBBISH
BIN
LETS
YOU
KNOW
YOU'VE
ARRIVED!



THERE ARE, AMONGST US, CONSCIENTIOUS INDIVIDUALS
WHO TAKE THOSE FREE LITTER BAGS, FILL THEM UP
TO CAPACITY, THEN HEAVE THEM OUT OF THE CAR
WINDOW!

NEW ZEALANDER'S
LETHARGIC RESPONSE TO
LITTER IS THE MAIN
REASON FOR OUR PRESENT
PREDICAMENT.

FIRST OF ALL THERE IS THE
STRAIGHT OUT, NO MUCKING
AROUND LITTER BUG WHO
INSTINCTIVELY DROPS HIS
LITTER TO THE GROUND;

HOW THEN DO WE COPE WITH THE LITTER
THAT IS THREATENING TO TURN GOD'S ZONE
INTO GOD'S LITTER ZONE?

WHAT ARE WE, THE PEOPLE, DOING



EDUCATING PEOPLE WOULD SEEM TO BE THE ANSWER. THE NEW ZEALAND LITTER COUNCIL ATTEMPTED THIS WITH SOME POSTERS AND VERY FLACID TELEVISION AD'S.....



ONLY LAZY PEOPLE LITTER"



....WHOSE MOST FEARSOME STATEMENT IS - NEW ZEALAND IS TOO LOVELY TO LITTER.

NOT GOOD ENOUGH!

IF IT WORKED FOR NILVERM IT MUST WORK FOR THE LITTER COUNCIL!

MIND YOU - THERE MIGHT BE THOSE WHO WOULD IGNORE EVEN THIS - NAMELY THE MOST COMMON LITTERING OFFENDERS, THOSE BETWEEN THE AGES OF 15 AND 23.

WHAT WE NEED IS SOMETHING STRONGER TO BRING HOME THE MESSAGE, BECAUSE IT WOULD SEEM SOCIETY HAS PROGRAMMED US SO THAT WE WILL ONLY REACT TO PUNISHMENT, VIOLENCE AND SHOCK TREATMENT.

NOW, IF THOSE THREE CONCEPTS WERE INCORPORATED INTO THE MEDIA (TELEVISION FOR INSTANCE) NEW ZEALANDERS WOULD RAISE THEIR HEADS AND THE OBNOXIOUS HEAD OF LITTER WOULD BE DECAPITATED.

HOW ABOUT IMPLEMENTING THIS IDEA ON T.V.?

THE PORTRAYAL OF THE AGONY, THE DECAY, THE HORROR OF A HUMAN STRUCK DOWN BY TYPHOID - TYPHOID CAUSED BY THE UTTER FILTH OF LITTER.....

....OR AN ADVERTISEMENT DEPICTING THE AMPUTATION OF AN ARM OR A LEG BONE SEPTIC FROM A CUT BY BROKEN GLASS - THE FATAL INJURY SUSTAINED FROM RUSTING METAL.

THIS KIND OF TREATMENT PROVED EFFECTIVE IN THE NILVERM AD' - YOU KNOW THE ONE.....

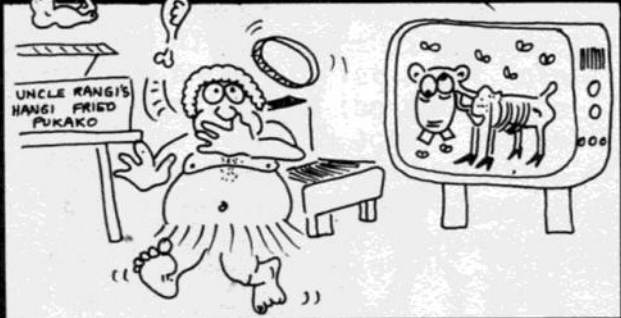

..WITH THE WORM-RIDDED SHEEP THAT ALWAYS CAME ON AT DINNER-TIME!



WHY?

PERHAPS IT IS A MEANS OF REVOLT AGAINST AUTHORITY, OR PERHAPS THEY ARE IN THE FINAL STAGE OF PERSONAL DEVELOPMENT.

WHATEVER THE REASONS, WE CAN HURT THESE PEOPLE WITH MONETARY PUNISHMENT IMPLACIBLY APPLIED.

IN SINGAPORE, FINING LITTER OFFENDERS \$200 HAS PRODUCED AN ASTOUNDING RESULT UNEQUALLED ANYWHERE IN THE WORLD - A LITTER-FREE COUNTRY!

WITHIN THIS AGE PERIOD, LITTERING HABITS DECLINE TO THE DEPTHS OF DEGRADATION.

OBVIOUSLY, IT IS IMPORTANT THAT THIS FORM OF CONTROL BE INTRODUCED INTO NEW ZEALAND, AND IT HAS BEEN - NOT ON A PERSONAL LEVEL, BUT ON A NATIONAL LEVEL.

LEGISLATION CONCERNING LITTER WAS INTRODUCED INTO N.Z. IN 1968 AND WAS AMENDED IN 1979. IT CONSISTS OF A LITTER CONTROL PLAN FOR N.Z. AND AN ASSESSMENT AND EVALUATION OF AN ALTERNATE MEANS OF LITTER CONTROL.

HOWEVER, NOT MANY OF US ARE AWARE OF THIS LITTER ACT, AS ONLY HAMILTON, AUCKLAND, MANUKAU, OREWA AND 13 OTHER COUNTY COUNCILS HAVE ADOPTED THE LEGISLATION BY IMPLEMENTING A STRATEGY OF FINES TO COMBAT THE CRISIS.

USUALLY A \$20 FINE IS IMPOSED UPON ANY PERSON CAUGHT LITTERING. UNFORTUNATELY THE FINE IS NOT INSTANT BUT IS BASED UPON THE INFRINGEMENT NOTICE SYSTEM, AND THE OFFENDER HAS 14 DAYS TO PAY.

A LITTER FINE CAN NOT BE UNDONE BY MERELY PICKING UP THE LITTER. THE OFFENCE IS IN THE THROWING DOWN OF IT.

THE LITTER OFFICER FOR HAMILTON DEFINED LITTER AS "ANYTHING NO LONGER REQUIRED BY MAN AND DUMPED IN AN INAPPROPRIATE AREA."

THE ACTUAL FINE COMES WITHIN FIVE HEADINGS:

1. THE PEDESTRIAN THAT LITTERS.
2. THE MOTORIST THAT LITTERS.
3. SPILLS FROM UNCOVERED TRAILERS AND COMMERCIAL VEHICLES.
4. ACCUMULATING LITTER THEN DEPOSITING IT IN AN INAPPROPRIATE AREA.
5. THE PUTTING OUT OF THE WRONG REFUSE CONTAINER AS DEFINED BY THE SPECIFIC COUNTY COUNCIL.

FROM THIS DEFINITION OF LITTER THAT COVERS SO WIDE AN AREA WE CAN APPRECIATE THE PROBLEM IN TRYING TO POLICE AND ENFORCE THE LITTER LAWS, BUT WE CAN BE ASSURED ACTION IS BEING TAKEN.

IN ADDITION TO THAT, LITERATURE CAN BE OBTAINED FREE FROM ALL COUNTY COUNCILS, AND ALL LITTER OFFICERS ARE AVAILABLE TO SPEAK TO INDIVIDUALS AND INSTITUTIONS SUCH AS SCHOOLS, FACTORIES AND BUSINESSES. WHILE MONETARY PUNISHMENT MUST BE USED TO CRIPPLE LITTER, AND SHOCK TREATMENT OF THE NILVERM TYPE COULD HELP ENORMOUSLY, THESE ARE NEGATIVE WAYS OF KEEPING OUR COUNTRY CLEAN.

PERHAPS A MORE POSITIVE APPROACH ARE REWARDS AND INCENTIVES....



A REFUNDING SYSTEM ON ALL CONTAINERS.....

REFUNDS



SUCH AS WE HAVE WITH GLASS BOTTLES MIGHT BE POSSIBLE. IT HAS PROVEN EFFECTIVE BECAUSE GLASS IS A MINOR SOURCE OF LITTER TODAY. A CASH REDUCTION OFF A PRODUCT WITH THE RETURN OF THE EMPTY PACKET IS ANOTHER POSITIVE APPROACH TO THE PROBLEM.



ARE WE THE TYPE OF PEOPLE TO TOLERATE SUCH FILTH AND DISGUST? ARE WE PREPARED TO LET LITTER, THE DEVASTATION OF BEAUTY AND ULTIMATE DESTRUCTION OF THE ENVIRONMENT, RUN RIFE IN OUR COUNTRY? IT IN A CAN.



...YES! EVEN SPEECH COMPETITIONS!

BUT - WHETHER WE USE THE NEGATIVE APPROACH OF SHOCK TREATMENT AND MONETARY PUNISHMENT, THE POSITIVE METHOD OF REWARDS + INCENTIVES, OR BOTH, N.Z. MUST GET OFF THEIR BUTTS AND GET IN BEHIND THIS WAR THAT IS BEING WAGED AGAINST LITTER AND ALL OF ITS APPALLING ATROCITIES.

A LITTER-FREE N.Z. IS NOT IMPOSSIBLE. SINGAPORE PROVED THAT, AND SO TOO MUST WE. I KNOW WE CAN DO IT BECAUSE - IF ANYBODY CAN THE KIWIS CAN SO C'MON, PUT IT IN A CAN.

KORIMAKO SPEECH WINNER 1981



DALE TIMMS

An old man, an age of experience etched into the lines of his face, lay still in his bed. Gathered about him were his seven quarrelsome sons. They all jostled and vied for his attention, eagerly awaiting his word. "Son," he said, "My time is near and my vast expanse of land must be divided evenly amongst all seven of you,

(40)

so you will have an equal chance of prosperity." Instantly a political pandemonium of aggravated shouting arose. "I'm the eldest, I should have the land! It is tradition!" said one voice. "No!" said another, "I've been learning to farm for three years. I should have it!"

"No-way," said one of them, "I've got mining shares invested in it!"

It was as the old man had feared. If he were to leave the land to his seven sons they would fight and argue, neglecting the land, letting it go rack and ruin.

The brothers continued to fight. The scene was reminiscent of the Muppet Show and a Parliament Debate all in one.

From amongst the pillows and blankets the old man yelled "Silence!" He rose like a wirey weed and swayed as if blown by some invisible breeze. From under the covers he pulled out seven intricately carved kauri sticks, bound tightly by a beautiful flax rope perfectly interwoven with threads of many colours.

The old man, to his puzzled sons who had become unusually quiet, said "He who can break the sticks shall have my land."

Well, the brothers Oohed and Ahhed, but no matter how much wrath they brought to bear upon the bundle, none could carry out the task.

"Bring it here," said the old man.

The youngest brother did as was requested and in a fleeting moment with the ferocity of a tiger, the old man tore the rope and let the sticks fall separately.

Then one by one, he picked up each stick and with long tortuous movements broke each of them. He fell back into bed, exhausted.

"You see, my sons, the strength of togetherness. Alone, and like fools, the sticks break under pressure of even an old man."

With that his body became limp and his hands fell among the debris. From that day forth his sons behaved more like brothers and less like politicians. They did not argue, they cooperated to become fullfilled, prosperous young men.

On his dying day the old man had taught his sons an invaluable lesson that the whole world can learn from. For as the 7 sticks represented the 7 sons so do they represent the 7 continents of the world. And as the flax rope represented togetherness, so too does it represent brotherhood - the brotherhood of man!

Brotherhood is more than just a word; it is a concept, enhancing love, understand-

ing, tolerance, cooperation and compromise. It is a bond meticulously made by the intimate hands of time so all men could prosper.

It is a bond that is framing around the It is a rope with many threads missing. Why? Because tyrants, meatheads, war mongers, bitter infested men are creating hate and disharmony - disharmony that we are fool enough to let erupt into a volcanic disaster for the human race. We are not so naive to accept and believe what these disillusioned mutation of mankind say. We are not so damned stupid as to let them break the rope and carelessly break the kauri sticks and, inevitably, the world.

The 7 continents and all their people must, as did the 7 brothers, see the light and forget the fight. We must pull together for brotherhood and heal all wounds, bridge all gaps, unite all men.

Man is the only power on earth able to destroy man; yet by the same token only man can protect man from such a foolish ending as a nuclear holocaust where we will all be individually incinerated like idiots!



On Wednesday 9th July the school had the honour of hosting the 1981 Waikato Area Korimako Junior & Senior Speech Competition. About thirty students participated from throughout the area, amongst them our own representatives Faryn Matthews and Dale Timms.

The large audience responded well to the high standard of competition.



Mr J. Kelly, Judge
 Many topics were discussed, all very relevant to New Zealand Society, especially problems facing the Maori people today.

Judith Hartstone, Leanne Tyrie and George Simon introduced the contestants, and found the task a nervous, but rewarding experience. They now know the problems of "keeping the show on the road".

Leanne and Judith had fun keeping close to correct Maori pronunciation. With fluent speakers in the audience, one couldn't make too many mistakes!

Both of our own participants did well, representing our school with creditable enthusiasm. Dale Timms notched up yet another win in the Senior Section and earned the right to speak in the National Finals in Wellington. The home supporters were delighted!



VALEDICTORY

BRONWYN PAURINI joined her husband here in 1980 after teaching a section here also in 1979. As her section was so enjoyable she applied for, and got, a teaching position with us.

Training was accomplished at Canterbury and Otago Universities with the finishing off being done at Waikato University. The Paurinis have been married 4 years, and Mrs Paurini is now looking forward to the first of her two children, while this is the first of 3 for her husband! A compromise should produce a starting 5 for basketball!

With the baby due on February 10th in 1982, we all wish her well in her new role of motherhood.



MUSIC

THE SEVEN SEAS MUSIC GROUP

The group originally started out with four members, but continued to grow until it had seven musicians.

Seven Seas this year has practiced and performed at the Wales Bank Music Competition which was held at Southwell

School in Hamilton. They have also performed at some functions such as the Parent-Teacher Association and Primary School gatherings.

Members are: Catherine Gould (Synthesizer), Joseph Tahana (Trombone), Michael Williamson (Bass Guitar), John Bell (Guitar), Donna Ranga (Clarinet), Pierre Clarke (Guitar) and Anthony Paekau (Drums).

- Donna Ranga



REAR: C. Gould, M. Campbell, R. Coenen, G. Runciman, J. Tahana, S. Parker, S. Smith, M. McCarthy.
SEATED: S. Chrystall, R. Blisset, R. Schimanski, A. Johnson, H. Whitfield, M. Williamson, J. Bell

Maopi Cultupe

E nga iwi, e nga matua tupuna tena koutou, tena koutou, tena koutou katoa.

Te arikinui Te Atairangikaahu, to hoa tane me ta korua whanau nga mihi kia koutou katoa.

The year 1980 has come and gone again, but we have had our exciting moments. Our trip to the Cultural Competitions, held this year in Whakatane, was most enjoyable. A younger group than previous years was predominant; the group being comprised mainly of third and fourth formers. Although we did not gain any trophies, the enthusiasm shown by our younger

third formers was evident. I noticed some of them being 'stagestruck' perhaps, but that is usually overcome with experience in public. Our stay at the marae was enjoyable, having had the good fortune to stay with Hamilton Boys' High School and Sacred Heart Girls' College. The socializing of the groups was a lesson on its own: it was very encouraging to see everyone mixing. Our trip home via Mount Maunganui was also enjoyable, although a bit spoilt by the weather.

Later in the year the school played host to the Korimako Speech Competitions, and again the Cultural



REAR: H.Aramete, M.Gray, K.Clark, M.Simon, S.Muru, R.Roberts, H.Paul.
 3rd ROW: M.Simon, T.Tai, B.Cocup, R.Kirkwood, P.Whareaitu, M.Sketchley, M.Turner,
 D.Mahara, P.Paikea.
 2nd ROW: N.Dixon, A.Paul, G.Williams, T.Watson, B.Katipa, P.Harding, S.Monsall, R.Barton,
 Hekewaru Muru.
 SEATED: P.Wade, K.Andrews, S.Waters, J.Graham, W.Tukere, N.Henare, C.McTainsh, M.Haunui,
 M.Mahara.

Group came to the fore. This was a highlight for the group and I am certain the whole school, pupils and teachers alike, were a proud lot that day. Everything went like clockwork and my appreciation and thanks to all the teachers and pupils who assisted in the organisation. It does show that teamwork achieves worthwhile results. To our senior pupils who contributed during the competitions an excellent job was done! Of course we have to again congratulate Dale Timms, who was successful, and who eventually went through to succeed in the National Finals at St. Stephens College. A great way to complete

your school years at Ngaruawahia High Dale.

A visit by a Fijian Rugby team, once again brought the group into focus, a challenge (wero) was performed at the school.

Their singing was greatly admired and I am certain that staff and pupils present thoroughly enjoyed the visit.

Our end-of-year activity usually include a visit to Taupiri to entertain the senior citizens.

I would like at this stage to thank Wynae, Momo, Aroha, Hekewaru and other seniors who assisted in the the timing of the group, and hope everyone will be refreshed from the holidays for a new start next year. No reira e hoa ma kia ora koutou katoa.

SCHOOL CERTIFICATE 1980

ABERHART Shelley	FISHER Sandra	KATIPA Hoki	SCOTT Linda
ASHLEY Karen	FRATER Karen	LOVERIDGE Fiona	SHARP Susan
BEGBIE Penny	McKEE Kerry	LOVELL Howard	SMITH Wendy
BELL Raewyn	McLEAN Alan	MAGEE Kerry	SOLOMON Vicki
BENNENBROEK Truusje	McILRAITH Neroli	MATAAFE Sandra	TAYLOR Vivienne
BIDOIS Angelique	McLEAN Heather	MUDGWAY Gary	TE WIATA Kim
BROWN Dean	McLEAN Linda	NIKORA Earl	TINI Roimata
CAIRNS Raymond	MILLS Bronwyn	NUZUM Wendy	TOURNIER Paul
CHRISTIE Owen	GRAVES Shane	OLIVER Ross	TUKERE Marae
BLACK Adrienne	GUTRY Rodney	O'CONNOR Anita	WALL Ross
CLAY Leslie	HARRIS Robert	PAKI Wainui	WARDELL Richard
CLELAND Beverly	HARRIS Robyn	PARATA Richelle	WARREN Philip
DALBETH Brenda	HARROP Louise	PAUL Arthur	WATERS Joy
DANIEL Hoki	HEAD Vivienne	PIHAMA Pourewa	WEST Justin
DASS Shindo	HAGGIE Carmen	PINKERTON Murray	WILLIAMS Brandon
DONCASTER Kim	HENRY John	PRESTON Nicole	WINDSOR Brett
DOUGLAS Paula	HINTON Natalie	PRITCHETT Caroline	WINIKEREI Matthew
DERECOURT Dorothy	HINTZ Murray	PUNCHEON Sharyn	WOOD Gary
EDWARDS Mark	HOPA Graeme	RIDLEY Gary	WRIGHT Brenda
ESSELBRUGGE Marguerite	HOPA Ma	ROE Tracey	ZIMMERMAN Andrea
	JOHNSTON Helen	SAVILLE Wendy	

UNIVERSITY ENTRANCE 1980 (SUBJECT PASSES)

BARAKAT Dale	DYSON Sheryl	MATAAFE Sandra	SIMON George
BARLOW Megan	GUTRY Craig	McPHERSON Leanne	SMITH Susan
BLACK Jaqueline	HARRIS Robyn	MURU Waata	SOLOMON Shane
BRIGHT Angela	HARTSTONE Claire	NIKORA Rachel	TIMMS Dale
BROWN Valerie	HARTSTONE Judith	OLIVER Grant	TYRIE Leanne
CALLAGHAN Dorothy	HODGKINSON Robert	PELLOW Michelle	VAN HOUTTE Elaine
CAMPBELL Shelley	JENNINGS Helen	PRENDERGAST Maria	VAN TIEL Martin
CRAWFORD Carol	JENNINGS Judith	ROBERTSON Sandra	VAN WOERDEN Robert
DOOLEY Heather	JOHNSTON Grant	SAYERS John	WRIGHT Robert
	LOVELL Loryn	SHARPE Susan	

BURSARY 1980

TAYLOR Margaret (A)



SOCCER



REAR: O.Allison, S.Smith, D.Puncheon.

CENTRE: C.Torrington, N.Newport, D.Allison, D.Parrish, S.Harrison, P.Phillips.

SEATED: B.Gurmel, K.Williams, W.Taha, S.Miller, M.McLaren, M.Ringrose, B.Maley.

Soccer at the school showed an increase in interest. Junior boys soccer was given a boost with 11 3rd-formers showing an interest initially, and this number increased as the season progressed.

The Juniors entered form 3B in the competition run by the Waikato Secondary Schools (W.J.F.A.). Their first game was against Te Kuiti away and this was combined with a visit to the Waitomo Caves, which built up team spirit which lasted throughout the season.

The competition was hard, but interesting and the team came out on top in the second round of the competition by beating Cambridge & Fairfield and by drawing with Huntly. Players to show ability were Sean Miller, Michael McLaren, Darren Allison, Neil Newport, Michael Ringrose, Bhutta Gurmel and Shane Harrison, ably supported by all the other boys.

Darren and Owen Allison had the rare distinction of both scoring hat-tricks in the same game. The Most Improved Junior for the year was Michael Ringrose. Neil Newport and Shane Harrison were the two most supportive team members with the most skillful player being Sean Miller.

RESULTS:

v. Te Kuiti	1-5
v. St Peters	1-5
v. Fairfield	3-1
v. Fraser	0-5
v. HBHS "A"	2-9
v. HBHS "B"	0-3
v. Hillcrest "B"	0-3
v. Cambridge	8-1
v. Huntly	1-0
v. Cambridge	win
v. Huntly	2-2
v. Fairfield	4-3





1st XI

The Senior Boys joined the local Club, Ngaruawahia-Affco United, and played in the 3rd Division of the Waikato League with merit. This was reflected in the team being awarded the Waikato Referee's Association Cup for the best and fairest team in the Waikato (all divisions). The team was captained by Brian Harding and team-member Gary Ridley was named by the Club as the Most Improved Player. Other students in the team were Keri Magee, Kerry McKee, Elliot Cathro, Richard Wardell.

Inter-school competition for the 1st XI met with mixed success, losing to Hillcrest 0-8 and Papakura 1-5, but defeating Tamaki 5-1. The highlight of the season was playing against Huntly in a keenly contested game and only going down 3-5. The game could have been ours, with all the lads playing very well.

2nd XI

Two composite teams were formed this year containing a mixture of juniors and seniors to play against Raglan, where they won 6-1 and lost 0-3 to Te Kuiti. Players who did their share of work for this team were Dean Puncheon, Stephen Smith, Owen Allison, Andrew Pharo, Murray Wills and David Hodge.



REAR: R. McIntosh, S. Smith, E. Cathro, B. Ridley, D. Puncheon, K. McKee, G. Fletcher, Mr Phillips
 SEATED: O. Allison, J. Bell, A. Pharo, B. Harding, K. Magee, P. Magee, M. Wills.



REAR: C.Crawford, J.Bradshaw, S.Myers, S.Schreiber, P.Begbie, M.Cargo.
 SEATED: D.Griffiths, S.Smith, G.Wood, J.Hartstone, A.Lewin.

BADMINTON

This year we were fortunate enough to be able to field a badminton team in matches against Hauraki Plains, Katika Katikati and Te Kauwhata all held at Hauraki Plains College. The team played well against some strong opposition.

The team comprised Gary Wood (Capt.), Scott Schreiber, Duane Griffiths, John Bradshaw, Judith Hartstone, Susan Smith, Penny Begbie, Carol Crawford and Sandra Meyers. Each player had his or her fair share of victories and losses in all games. Our thanks go to Mr Cargo, who made these matches possible.

The School Championships caused a lot of interest this year, especially in watching the amazingly talented duo of Dale Timms and George Simon. Although not able to win the champs, they succeeded in losing the plate final to Earl Nikora and Brian Sweet!

SEMI-FINALS

Gary Wood & Scott Schreiber
beat

John Bradshaw & Alan Lewin

Paul McMillan & Peter Lornie
beat

Duane Griffiths & Ross Wall

FINALS

Gary Wood & Scott Schreiber
beat

Paul McMillan & Peter Lornie

GIRLS FINAL

Kim & Lyn Rogers
beat

Judith Hartstone & Susan Smith

CREDITS

The production of the Magazine was in the hands of a small band of enthusiastic toilers this year:-

- Cover Photograph by ANDY CAMERON
- Cover Design by SANDY MACDONALD
- Cover Poem by KIRSTEN EXCELL
- Inside Cover Art by JOHN BELL
- Line Drawings by RODNEY GUTRY
- School Roll Compilation by JANET McBRIDE
- Financial Assistance from BUSINESS COMMUNITY and SENIOR STUDENTS
- Technical Advice from GOLDFIELD PRINT
- Typing by LINDA STONE, ELAINE HAGGIE and SANDY MACDONALD
- Valedictories by SENIOR STUDENTS
- Spelling Mistakes by NOBODY



Magazine Committee - DALE TIMMS, WENDY NUZUM, JUDITH HARTSTONE, JANET McBRIDE, LEANNE TYRIE, RODNEY GUTRY & SANDY MACDONALD (Staff).



THREE THIRD

On Sunday 8th November this year over 1500 teams took part in the Annual Fun Run around Hamilton's Lake Rotoroa, each team made up of three members.

TRACEY ROE, WENDY NUZUM and SHARYN PUNCHEON made up a Ngaruawahia High School Squad and ran in ahead of over 1497 other teams, coming third! More than 5000 runners participated.

AUTOGRAPHS

BADMINTON REP'S

Gary Wood represented Waikato in the Under 17 team while Kim and Lyn Rogers did likewise in the Under 15 squad.

Gary Wood, partnered by Glen Harris of Fraser High School, won the Under-17 Doubles Championships, with Gary coming Runner-up in the Singles and Mixed-Doubles Finals.

Kim and Lyn Rogers took out the Under 15 Doubles Title.

Gary also entered the Age Group Championships (National) and made it to the third round where he was eliminated by the eventual winner S.Tetai 5/15, 8/15. Again with partner Glen Harris he reached the quarter-finals of the Doubles but was beaten by third-seeds 10/15, 16/18. In the mixed Doubles Gary partnered A.Clark of Canterbury and lost to top-seeded players in the second round 4/15, 7/15. In the subsidiary Doubles Gary lost out 2/15, 2/15.

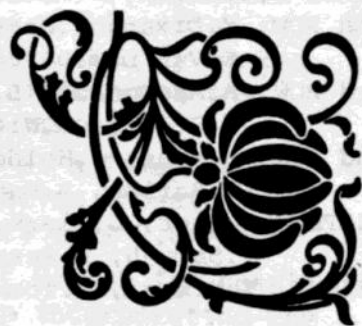

STAFF



REAR: C.Cameron, J.Moore, L.Stone.

4th ROW: H.Dixon, S.Cargo, M.Curtis, B.McLean, P.Phillips, B.Paurini, K.Crawford, F.Van Dam.

3rd ROW: A.MacDonald, L.Schneider, C.Grinter, J.Wardell, A.Johnson, D.Ashby, W.Braithwaite, J.Storey, R.Wigglesworth.

2nd ROW: P.Mans, J.Holden, T.Meadowcroft, J.Schaare, R.Bailey, H.Huirama, M.Cargo, P.Barlow, A.Paurini, K.Vallett.

SEATED: T.West, G.Clark, J.Sargeant, B.Robb, N.Murphy (Principal), F.Chappel, J.Templeton, P.Samujh, B.Esselbrugge.

ABSENT: Y.Nikora, F.Tomkins, I.Loveridge.

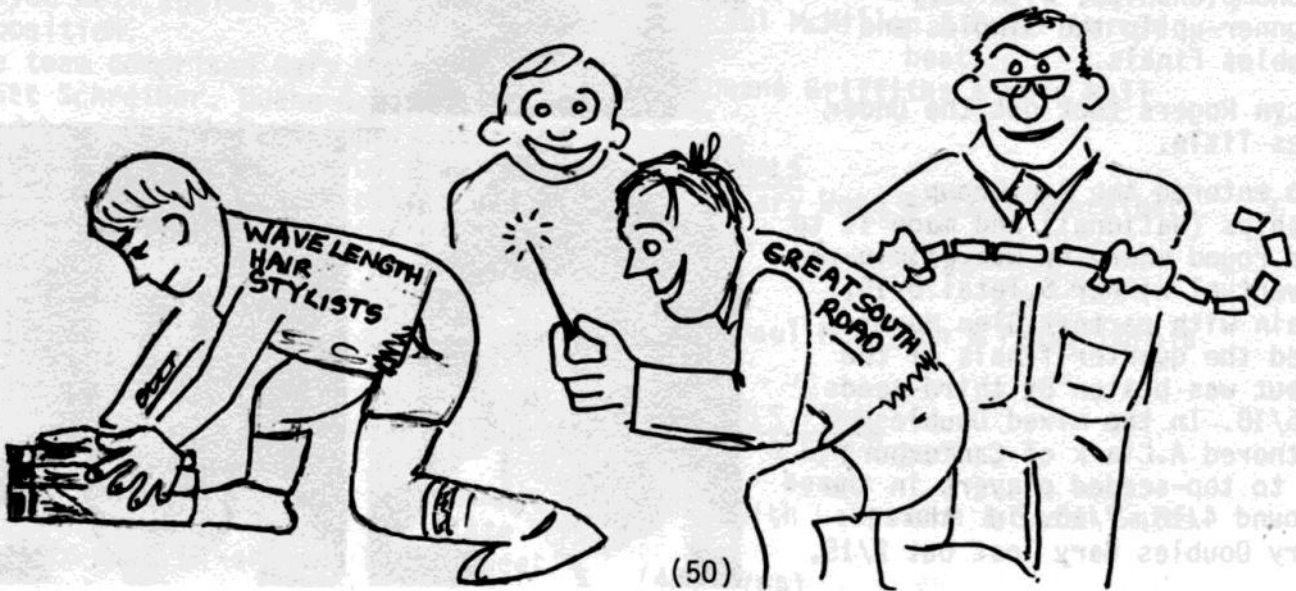

Great and marvelous are the antics to be seen and heard around and in the vicinity of the Staff Pool table each day. Groups of bemused students congregate on the terrace of P.4 and have almost a grandstand view through the Staff-room windows at the top-half of the staff pool-players. Many times reactions are mimicked as staff react to the differing situations on the table.

Competition has been high for placings on the "A" and "B" ladders, with no one person gaining permanent supremacy over other contenders.

The current "Table Clearing" champion is Arnie Paurini who managed to sink all 15 balls in a maximum of 15 strokes of the cue!

By the end of this year, regular players had asserted their personalities on the game and many were recipients of various Television awards for their performances.

GRINTER C. "The Young and the Restless" Cup for demonstrating plenty of action and little results.



WIGGLESWORTH R. "The Incredible Hulk" T-Shirt for the results of failed experimentation with the Pool cue.

CLARKE G. "The Gentle Touch" Sponge for his high percentage of soft shots.



CARGO M. "Star Trek" Wall Hanging for exploring new shots where no man has explored before.

MANS P. "Of Course You Can Do It" Goblet for his numerous attempts to get off the "B" ladder and onto the "A" ladder.

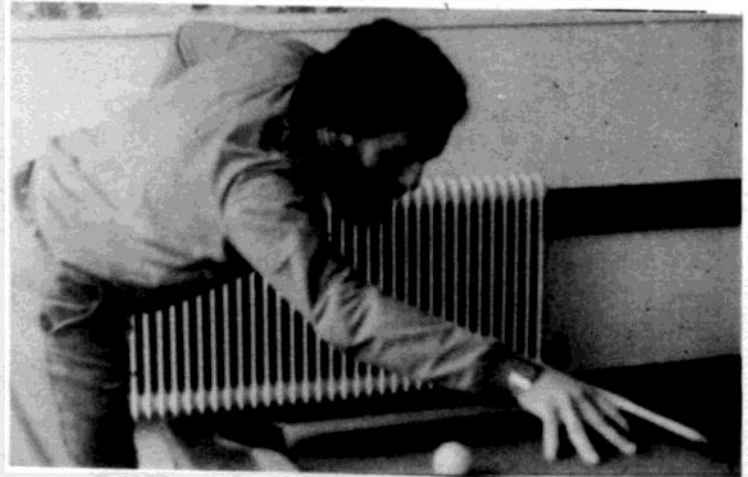

PHILLIPS P. "Days of Our Lives" Trophy for intense involvement in matches.

MEADOWCROFT T. "Dig This" Shovel gained by taking 5 efforts to break the triangle of balls in one game. Also the "Great American Hero" Flying Cape for not being sure of what will happen but risking the shot anyway.

SAMUJH P. "Agony" Plaque for a high number of successfully banked shots that often crush any incredulous opponent.

SCHNEIDER L. "One Day at a Time" Trophy for resisting repeated challenges from C,Grinter.

CARGO S. "Play School" Hammer for nearly succeeding in incorporating the Pool table in her mathematics program..ne.

PAURINI A. "M*A*S*H" Scalpel for his consistent rapier-like execution of shots.

MACDONALD A. "Kojak" all-day sucker for cool-headedness in the face of mean opposition.

SERGEANT J. "Trapper John - M.D." stethoscope for his painstaking operation of the cue.

SCHAARE J. "Solid Gold" Cup for style and grace exhibited when executing awkward shots of almost unreachable nature.

(51) PAURINI B. "Close To Home" Shower for at last requiring a longer cue.

GIRLS SOCCER



REAR: S.Tancred, D.Ranga, B.Cocup, L.Maniapoto, P.Thackray, M.Sketchley, Miss Crawford.

SEATED: P.Wade, L.Ridley, T.Williams, R.Nikora, S.Todd, R.Davies, D.Sargent.

ABSENT: C.Nelson, K.Deacon.

The girls team was reformed after a one year lay-off and performed with distinction. In 1978, the inaugural year of Secondary Schools Girls soccer, Ngaruawahia came out as Champions and came Runner-up in 1979. This season the girls entered in the 2nd Division and lost just 3 games, all by the odd goal.

RESULTS

v. Melville	2-1
v. H.G.H.S.	2-0
v. Morrinsville	0-1
v. Huntly	1-0
v. Hillcrest B	3-1
v. Melville	2-1
v. Cambridge	win
v. H.G.H.S.	3-0
v. Morrinsville	1-2
v. Fairfield	win
v. Huntly	0-1
v. Hillcrest	win

The team finished runners-up to Morrinsville, and with the experience gained this past season, look to do equally as well in 1982.

In inter-school visits, three games were played. At Hillcrest we were matched against their top team, but the girls did well and only went down 1-4. Against Huntly in the mid-term there was difficulty in fielding a full team. Huntly played with determination and we were stretched into really earning our 2-0 win. The trip to Papakura resulted in a 3-0 win to Ngaruawahia. It was interesting to note that Papakura fielded two teams - one in the first spell and a different line-up in the second! Ngaruawahia's positional play proved their strength in the win.



Debating



REAR: M. Simon, J. Bradshaw, S. Robertson, Mr West.

SEATED: L. Tyrie, J. Hartstone, D. Timms.

This year a senior team was entered in the 'Wales Bank Secondary School Debating Contest'. The team comprised: Judith Harstone, Dale Timms and Leanne Tyrie. Our first opponents were a team from Fraser High School and in front of an enthusiastic audience Ngaruawahia successfully affirmed that 'Intolerance is more dangerous than Ignorance'. We were fortunate to have Mr Ed. Turner as adjudicator and his constructive comments were much appreciated.

In the second round our team successfully negated the topic that: 'Life is a Cream Puff', at Te Kauwhata College. This was another interesting and evenly contested debate.

Our final contest was held at Ngaruawahia and Ngaruawahia was unsuccessful in affirming that: 'The World has learnt from History', against a very competent Sacred Heart College team. There is no doubt that our speakers gained in poise and self confidence as a result of these three encounters.

On the 26th of September our Junior Debating Team of Mia Simon, Susan Robertson and John Bradshaw, went to the Te Rapa Racecourse for the annual debate held for the Te Rapa Rotary Club, against Fraser High School.

We were warmly greeted by our hosts, who directed us to a magnificently laid table where we helped ourselves to a delicious meal.

After the dinner and the Rotorian business the debate commenced. The topic was 'That Women are in all Respects Equal to Men'. Ngaruawahia was taking the affirmative. Both teams had excellent arguments, and both were eager to win. Ngaruawahia was after the trophy following the narrow loss last year. Fraser's speakers had more facts and figures in their speeches, whereas Ngaruawahia added a bit more humor. After the announcement had been made that Ngaruawahia had won, and had received the trophy and had photos taken, an error was spotted on the score sheet. After it was all rechecked it was discovered that Fraser had won and not Ngaruawahia as had been read out. The trophy was sadly handed back to Fraser who will hold it for another year. The final score was Ngaruawahia 334 and Fraser 340.



The senior B team won the B-Grade Handicap and the B-Grade knockout and came runners-up in the B-Grade Championship in their Eastern Waikato Competition.

RESULTS

v. Raglan	25-19
v. Te Kuiti	21-22
v. Katikati	7-11
v. Te Kauwhata	21-7
v. Hauraki Plains	16-13
v. Papakura	11-31

netball

NETBALL



REAR: A.Paekau, M.Haunui, W.Gibb.
 CENTRE: J.Graham, Mrs Cameron.
 SEATED: M.Tukere, M.Prendergast, L.Solomon.

senior A

Congratulations to Captain Maria Prendergast who was awarded the Eastern Waikato Netball trophy for the player showing the most outstanding sportsmanship and playing ability.

RESULTS

v. Fairfield	28-17
v. Hillcrest	16-19
v. Te Kuiti	26-18
v. Hauraki Plains	21-15
v. Katikati	14-22
v. Te Kauwhata	21-11
v. Papakura	28-29
v. Forest View	20-29
v. Girls High	12-10
v. Fraser	14-18
v. Te Aroha	16-11
v. Cambridge	22- 9



REAR: A.Hopa, R.Ching, W.Gibb.
 CENTRE: B.Bailey, Mrs Huirama.
 SEATED: S.Puncheon, N.Gray, R.Bidois.

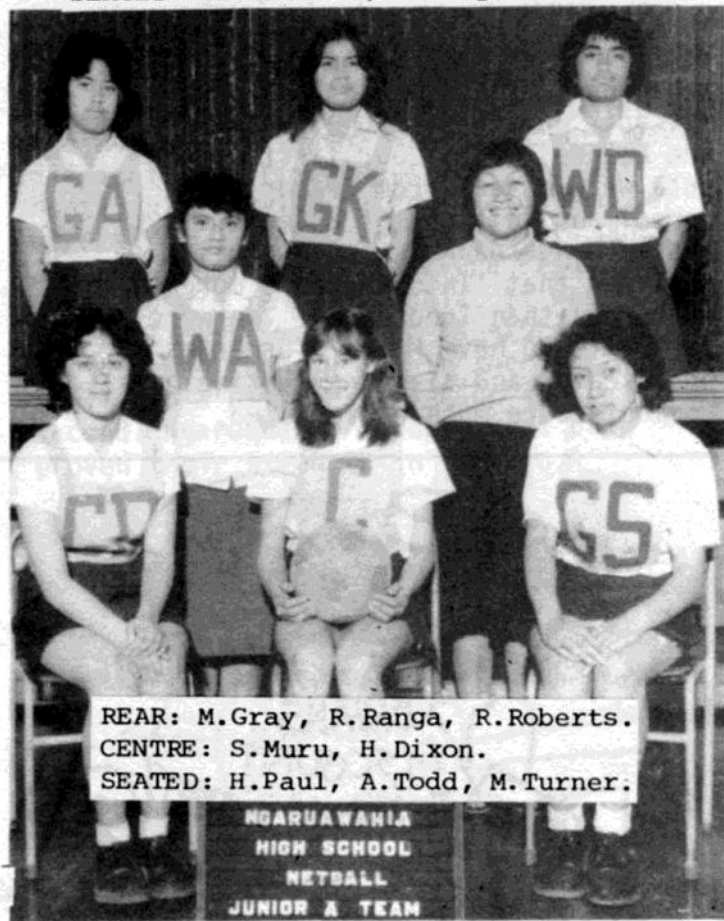

REAR: M.Gray, R.Ranga, R.Roberts.
 CENTRE: S.Muru, H.Dixon.
 SEATED: H.Paul, A.Todd, M.Turner.



REAR: K. Clarke, M. Mahara, F. Van Dam, L. Langley, S. Frater.

SEATED: M. Mahara, C. Anderson, D. Pavich, V. Wallbank, S. Tippings, R. Menzies,

VALEDICTORY

WARWICK BRAITHWAITE is a descendant of English Stock (human, not cattle) with talents in Piano and flute. He seemed to be always in trouble at school, rebelling against a tyrannical maths teacher. At Ardmore Teachers' College he instigated a riot against University Engineering and then called out the fire brigade to put a damper on things!

He was involved with the development of the Accelerated Exam Programme at Fraser High before obtaining the intensive position of 3rd Form Dean here.

Mr Braithwaite made an invaluable contribution to the 1978 tour to the United Kingdom by our Maori Culture Group. Next year he will be teaching 5th form English and Music at H.B.H.S.

We are sorry to see the loss of a friendly and most interesting teacher from the staff.



PRIZE LIST

IN THE LAST WEEK OF THE YEAR THE ANNUAL PRIZEGIVING CEREMONY WAS HELD. RECIPIENTS WERE PUBLICLY AWARDED THEIR TROPHIES AND PRIZES IN AN EVENING CEREMONY.

SPORTS AWARDS

Robin Bell Memorial Cup
(Intermediate Sprint Champ.)
HEKEWARU MURU

Grinter Cup
(Senior Boys Athletics)
ROSS WALL

Ang-Templeton-Harris Cup
(Most Improved Soccer Player)
DEAN PUNCHEON

Prendergast Shield
(Most Outstanding Soccer Player)
JOHN BELL & BRIAN HARDING

Kater Cup
(Most Improved Hockey Team)
"B" SQUAD (B. CLELAND, Capt.)

WARING TROPHY

Waring Trophy
(Most Improved Girl Hockey Player)
KIM STIRLING

Waikato Hockey Assn. Clark Shield
(Winners of 4th Grade)
BOYS HOCKEY TEAM (G. Wood, Capt.)

Tournier-Holden Trophy
(Best All-round Boy Hockey Player)
GARY WOOD

Robson Cup
(Badminton Boys Doubles)
GARY WOOD & SCOTT SCHREIBER

Ngaruawahia High School Cup
(Badminton Girls Doubles)
LYN ROGERS * KIM ROGERS

Eastern Waikato Netball Assn.
(Winners of Handicap Tournament)
SENIOR "B" TEAM

Eastern Waikato Netball Assn. Award
(Sportsmanship and Ability)
MARIA PRENDERGAST

Eastern Waikato Netball Assn.
(Winners of Knockout Tournament)
SENIOR "B" TEAM

McIntosh Cup
(Outstanding Junior Rugby Player)
PHILIP CLARKE

Daines Cup
(Most Improved Rugby Player)
JOSEPH TAHANA

Rugby Club Cup
(Contribution to Rugby)
GEORGE SIMON

Fijian Schools Rugby Trophy
(Outstanding Player)
ROSS WALL

Founders Shield
(Inter-House Activities)
NEWCASTLE (R. CONNOLLY & S. PUNCHEON)

Davidson Cups
(Sportsmanship, Athletics, Games
and Swimming)

-Best all-round girl TRACEY ROE
-Best all-round boy ROSS WALL

Basketball Trophy
HEKEWARU MURU

Best Junior Basketballer
TONGA WHITE

FOR OUTSTANDING CONTRIBUTION TOWARDS THE TEAM -

Rugby 1st XV - WAATA MURU
Rugby 3rd XV - RAYMOND SALT
Rugby 4th XV - EVAN STOKES
Hockey "A" - LINDA McLEAN
Hockey "3" - JAN PLUMMER
Premier Boys Basketball - ARTHUR PAUL
JOSEPH TAHANA

4A Boys Basketball - MAURICE KAIO
3A Boys Basketball - DONN STEPHENS (56)

Premier Girls Basketball - TRACEY ROE
Senior Girls Basketball - HOHI DANIELS
4A Girls Basketball - PURA HARPER
3A Girls Basketball - NIKKI HENARE
Soccer 1st XI - ELLIOT CATHRO
Soccer Juniors - NEIL NEWPORT
3A Netball - ANITA TODD
Senior Netball - MARIA PRENDERGAST
Tabletennis - STEVEN COCUP

1981 SCHOOL CHAMPIONS

ATHLETICS

Junior Boys - PHILLIP CLARKE
DEREK LAUDER
Intermediate Boys - HEKEWARU MURU
Senior Boys - ROSS WALL
Junior Girls - KIM STIRLING
Intermediate Girls - JAN PLUMMER
Senior Girls - TRACEY ROE

CROSS COUNTRY

Junior Boys - JACK TAHANA
Intermediate Boys - AARON WEST
Senior Boys - PETER LORNIE
Junior Girls - DENISE COLLINS
Intermediate Girls - JAN PLUMMER
Senior Girls - DALE BARAKAT

SWIMMING

Junior Boys - DUANE GRIFFITHS
Intermediate Boys - CLIFFORD McROBERTS
Senior Boys - RAYMOND CONNOLLY
Junior Girls - MA SIMEON
Intermediate Girls - JAN PLUMMER
Senior Girls - MARIA PRENDERGAST



FIRST IN SUBJECT

FORM 5

Typing - TRACEY CAMPBELL
Shorthand/Typing - CAREY BULLEN
Woodwork -
Engineering - RICKY COENAN
Technical Drawing - WHITI TUKERE
ANDREW HAULTAIN
Woodcraft - KARORIA MORGAN
Art - JOHN BELL
Economic Studies - MIRANDA CAMPBELL
Maori Language - AMY HOPA
Geography - DAVID HODGE
History - BELINDA HILL
Biology - ANGELIQUE BIDOIS
Mathematics - BELINDA HILL
Science - MIRANDA CAMPBELL
French - CAREY BULLEN
German - LINDA HILL
English - BELINDA HILL
Clothing - TRACEY STEPHENS
Home Economics - FAITH DEACON

FORM 6

Art - JUSTIN WEST
Maori Language - MARAE TUKERE
Technical Drawing - RAYMOND CONNOLLY
Accounting - BEVERLY CLELAND
Physics - TRACEY ROE
Economics - ANDREA ZIMMERMAN
Mathematics - BEVERLY CLELAND
Chemistry - TRACEY ROE
History - MARAE TUKERE
French - TRACEY ROE
Biology - ANDREA ZIMMERMAN
Geography - LOUISE HARROP
English - TRACEY ROE
Typing - WENDY SMITH & FIONA LOVERIDGE

FORM 7

English - LEANNE TYRIE
Biology - LEANNE TYRIE
Chemistry -
History - SHANE SOLOMON
Economics - SHANE SOLOMON
Pure Mathematics -
Applied Mathematics - WAATA MURU



SPECIAL AWARDS

Whitecliffs Award for Woodwork
BRYCE O'HEARN

Silver Mallet for Woodwork & T.D.
MURRAY WILLS

Racheal Walker Trophy for Homecraft
PETER WILLIAMS

Sloane Cup for Clothing
COLEEN McSWEENEY

Ian Brownlee Cup for Geography
JUDITH HARTSTONE

Jeanne Gilbert Cup for Languages
TRACEY ROE

McNamara Cup for Science
LEANNE TYRIE

Marsters Cup for Chemistry
MARTIN VAN TIEL

Ives Cup for Mathematics & Physics
MARTIN VAN TIEL

Speech Contest Winners
BELINDA HILL (Senior)
JOHN BRADSHAW (Form 4)
FARYN MATTHEWS (Form 3)

Best Maori Scholar
SHANE SOLOMON

Waikato Goethe Society Competitions
for 23 Schools
LINDA PARK (1st equal Senior)

Douglas Stone Cup for Drama
DALE TIMMS

Pharo Prize for Best Secretarial Student
SHARYN PUNCHEON

Contribution to School Music
PIERRE CLARK & JOHN BELL

Diane Harper Cup for Leadership in Music
MIRANDA CAMPBELL & JOSEPH TAHANA

Hon. W.Birch Prize for 5th Form Science
MIRANDA CAMPBELL

Alliance Francaise
TRACEY ROE

Latta Cup for Special Endeavour in Music
DONNA RANGA

Maori Trust Award for Leadership in the
Cultural Group
WYNAE TUKERE & HEKEWARU MURU

Erana Coulter Award for Maori Studies
and Contribution to the Community
MOMO HAUNUI

Librarian's Award
LEANNE TYRIE



Violet Jolly Cup for Citizenship
MARIA PRENDERGAST

Collins Cup for Citizenship
WAATA MURU

Chairman's Prize for Leadership
LEANNE TYRIE

Te Rapa Rotary Award for Outstanding
Contribution to the School
DALE TIMMS

School Leaders Awards
JUDITH HARTSTONE & DALE TIMMS

D.J.Carter Cup & Medal for Dux
LEANNE TYRIE

Award For Service
RAYMOND CONNOLLY

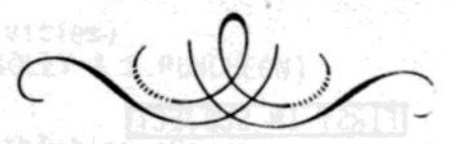
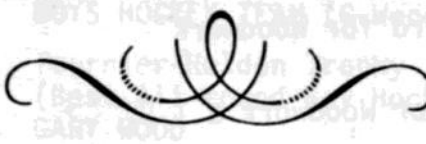

AUTOGRAPHS

ABBOTT Tracey	CHANDLER Leslie	FISHER Sandra	HERDMAN Chris	LOVELL Howard
ABERHART Shelley	CHING Rang	FITNESS Monica	HENARE Ceasar	LOVERIDGE Fiona
ACHERMAN Sharon	CHRYSTALL Stephen	FLETCHER Carolyn	HENARE Lee	LUFF James
ALLAN Stephen	CHRYSTALL Tony	FLETCHER Derek	HENARE Niki	MACKRELL Stuart
ALLEN Jackie	CLARK Kathleen	FLETCHER Grant	HENARE Shirley	MACKRELL Warren
ALLISON Darren	CLARKE Phillip	FRAMPTON Rodney	HENRY Kate	MAGEE Keri
ALLISON Owen	CLARKE Pierre	FRANGOS Paul	HERANGI Karaipo	MAGEE Peter
ANDERSON Brian	CLARKE Jackie	FRANGOS Selena	HEREMAIA Joseph	MAHARA Brian
ANDERSON Carol	CLAY Leslie	FRANKHOUSER David	HEWETSON Stephen	MAHARA Donna
ANDERSON David	CLAY Matua	FRANKHOUSER Dennis	HILL Belinda	MAHARA Maine
ANDREWS David	CLELAND Beverly	FRANKHOUSER Gary	HILL Roland	MAHARA Memory
ANDREWS Kym	CLELAND Graeme	FRANKHOUSER Janice	HINCH Robert	MAHARA Manaki
APIATA Juanita	COCUP Beryl	FRATER Leoni	HINTON Earl	MAHARA Mirissa
ARAMETE Horo	COCUP Steven	FRATER Stephanie	HINTON Natalie	MAHARA Richard
ASHLEY Bronwyn	COENAN Ricky	GAMBRILL Iain	HINTZ Erin	MAHARA Robert
ASHLEY Karen	COKER Judith	GEORGE Toro	HINTZ Robin	MAHARA Shona
ATTRIL Dale	COKER Russell	GIBB Wendy	HITCHENS Jimmy	MALEY Brett
	COLLINS Alan	GIELEN Loretta	HOANA Joanne	MANIAPOTO Jaycee
BAILEY Betty	COLLINS Denise	GILL Peter	HODGE David	MANIAPOTO Lillian
BARAKAT Dale	COLLINS Julie	GILLIES Ronnie	HODGE Jennifer	MARTIN Joseph
BARTON Reece	COLLIS Graeme	GOOLD Catherine	HODGKINSON Paul	MARTIN Robbie
BAIRD Allison	COLLIS Michael	GOTHORPE Corrina	HOLDEN Andrew	MARU Tini
BECKHAM Harley	COMMINS Rhonda	GRAHAM Janice	HOLLAND Dean	MATAAFE Sandra
BEDDIS Bryan	COMMINS Shane	GRAVES Shane	HOLLOWAY Alan	MATATAHI Arthur
BEDDIS Caroline	CONNOLLY Raymond	GRAY Aaron	HONA Jo	MATATAHI Paula
BEBBIE Adam	COTTER Tracey	GRAY Meda	HOOKER Kevin	MATATAHI Queenie
BEBBIE Penny	CRAWFORD Carol	GRAY Nita	HOPA Amy	MATENGA Barrett
BELL John	CROWHURST Stephen	GRAY Philip	HOPA David	MATHEWS Paul
BELL Raewyn	CROWTHER Faye	GRAY Thomas	HOPA Polly	MATTHEWS Aroha
BENNENBROEK Trusje	CROWTHER Stephen	GRIFFITHS Duane	HOPA Scott	MATTHEWS Faryn
BENNETT Warren	CURTIS David	GRASON Christine	HOUGHTON Jason	McBRIDE Janet
BENNY Robin	DALBETH Brenda	GURNICK Leslie	HOUGHTON Sandra	McBURNEY Darrel
BIDOIS Angelique	DALBETH Jeannine	GURMEL Butta	HUTT Lisa	McBURNEY Sonya
BIDOIS Rosealine	DANIEL Hohi	GURMEL Surinder	INIA Wayne	McCARTHY Frederick
BLISSETT Gail	DASS Bimla	GURMEL Lakshmi	JACKSON Gillian	McCARTHY Margaret
BLISSETT Roy	DASS Shindo	GUTRY Rodney	JACOBS Aue	McGREGOR Julianne
BLUNDELL Paula	DAVIES Diane	HAGGIE Carmen	JACOBS Julia	McILRAITH Neroli
BOOTH Sharon	DAVIES Roka	HANES Louise	JAMIESON Cameron	McINTOSH Rodney
BORRELL Brett	DEACON Faith	HANSEN Timmy	JEANES Maree	McKEE Kerry
BRADSHAW John	DEACON Kerry	HANSEN Wendy	JENNINGS Stuart	McLAREN Michael
BRIDGEMAN Craig	DEAN Matiu	HARRISON Claire	JOHNSTON Grant	McLAREN Stephen
BRIDGEMAN Shona	DERECOURT Raewyn	HARRISON Shane	JOHNSTON Helen	McLEAN Heather
BRIDGEMAN Wayne	DOCHERTY Christine	HARDING Brian	JOHNSTON Stephen	McLEAN Julie
BRIGHT David	DOOLEY Ian	HARDING Paul	JONES Vaughan	McLEAN Linda
BROEKS Martin	DOUGLAS Paula	HARMAN Anna	JOSEPH Peri	McMILLAN Paul
BROWN Angela	DRYBURGH Carol	HARPER Pura	KAIO Maurice	McNALLY Fiona
BROWN Ken	DUFFUL Johnnie	HARRIS Janet	KAITAKI Raymond	McROBERTS Clifford
BROWN Michael	DUFFUL Tui	HARROP Louise	KATIPA Ben	McSWEENEY Colleen
BRUCE Kathy	EDMONDS Nigel	HARTSTONE Craig	KATIPA Tia	McSWEENEY Robert
BUCHANAN Vicky	ENEVOLDSEN Shaun	HARTSTONE Gayle	KATIPA Waru	McTAINSH Cindy
BULLEN Carey	ENGLAND Donna	HARTSTONE Jocelyn	KIRKWOOD Rongo	MEAGHER Lisa
CADDIGAN Grant	ESSELBRUGGE Marguer	HARTSTONE Judith	KNIGHTON Grant	MENZIES Robyn
CAMPBELL Julie	EVERLEIGH Douglas	HARTSTONE Michael	LANLEY Lisa	MIDDLETON Angela
CAMPBELL Miranda	EVITTS Alan	HAULTAIN Andrew	LAUDER Derek	MIDDLETON Tonga
CAMPBELL Tracey	EXCELL Inger	HAUNUI Momo	LAW Brenda	MILLS Carmen
CAPPER Jane	EXCELL Kirsten	HAUNUI Wiri	LAWRY Heather	MILLS David
CARROLL Leo	FAIR Natalie	HAZELTON Matthew	LEWIN Alan	MILLS Linda
CARTER Brent	FAIRWEATHER Daryl	HEAD Dallas	LITT Helen	MILLER Dean
CATHRO Elliot	FISHER Mary-Ann	HEAD Tony	LORNI Peter	MILLER John
CATHRO Zane		HEAD Vivienne		MILLER Sandra

MILLER Sean	PARATA Richelle	RIDLEY Leanne	STEPHENS Donn	VANDY Ellen
MILLER Stuart	PARK Linda	RINGROSE Helen	STEPHENS Shane	VANDY Peter
MITCHELL Dianne	PARKER Sheree	RINGROSE Michael	STEPHENS Tracey	VANDY Steven
MOANA Joanne	PARRISH David	RITE Malvina	STEVENS Matthew	VAN HOUTTE Eric
MOANA June	PAUL Adam	ROBERTS Rangi	STIRLING Kerry	VAN TIEL Martin
MOANA Stephen	PAUL Arthur	ROBERTSON Kevin	STIRLING Kim	VAN WOERDEN David
MONSALL April	PAUL Gary	ROBERTSON Susan	STOKES Evan	VERNAL Gavin
MONSALL Shane	PAUL Hinemoa	ROBINSON Jeffrey	STRATFORD Scott	VINCENT Donna
MONTGOMERY Anne	PAUL Scott	ROE Julie	SWEET Brian	WAAKA James
MORGAN Karoria	PAUL Shane	ROE Tracey	SWEET Wayne	WADE Patricia
MORGAN Mere	PAUL Stephen	ROGERS Kim	TAHA William	WAITERE Hoani
MOUNTNEY Janet	PAVICH Debbie	ROGERS Lyn	TAHANA Jack	WAITERE Leo
MOUNTNEY Susan	PEEBLES Gavin	ROWE Stephen	TAHANA Joseph	WAIWIRI Paul
MORUNGA Jodi	PERHAM Kay	RUNCIMAN Glennis	TAHANA Sarah	WAIWIRI Peter
MUDGWAY Gary	PERHAM Leanne	RUPAPERIE Danial	TAHAPEHI Wiari	WALHORN Graham
MURDOCH Glenise	PHARO Andrew	RUPAPERIE Denise	TAHU Diane	WALL Ross
MURRAY Ian	PIHAMA Dean	RYAN Joseph	TAHU Pauline	WALLBANK Valerie
MURRAY Lindsay	PIHAMA Reuben	RYAN Martin	TAI Maude	WALTERS Colleen
MURRAY Thomas	PIHAMA Rewa	SAHIB Ahmed	TAI Tania	WALTERS Helen
MURU Hekewaru	PINKERTON Murray	SALT Marie	TAIRAKENA Riki	WARDELL Richard
MURU Hurinui	PINKERTON Roger	SALT Raymond	TAIRAKENA William	WARREN Rebecca
MURU Kiekie	PLUMMER Jan	SAM Donald	TAKA Kiwi	WATERS Joy
MURU Manawa	POKAIA Tukua	SAM Elaine	TAMATI Martha	WATERS Shannette
MURU Sharon	POMPEY Becca	SARGENT Bruce	TANCRED Sophie	WATERS Wayne
MURU Wayne	POMPEY Shane	SARGENT Denise	TATA Matthew	WATSON Terry
MURU Waata	POWLESLAND Amanda	SARNEY Mark	TAYLOR Colin	WEBB Fiona
MYERS Sandra	PRENDERGAST Carmel	SAVAGE Geoffrey	TAYLOR David	WEST Aaron
NELSON Carla	PRENDERGAST Dean	SAVILLE Nicola	TAYLOR Robyn	WEST Justin
NELSON Ricky	PRENDERGAST Maria	SCANDLYN Helen	TAYLOR Vivienne	WHANGA Sidney
NEPIA Angela	PRESTON Nicole	SCHIMANSKI Raphaela	TEKATA Kahu	WESTON Neil
NEPIA Malcolm	PRESTON Rowan	SCHREIBER Kirsten	TENGU Charles	WHANGA Sidney
NEWPORT Darren	PRIEST Natalie	SCHREIBER Scott	THACKRAY Paula	WHAREAITU Max
NEWPORT George	PRITCHETT Caroline	SCHWASS Jane	THOM Jerome	WHAREAITU Piki
NEWPORT Neil	PRITCHETT Rebecca	SCOTT Martin	THOMSEN Neville	WHITE Riki
NGAROTATA Karen	PROCTER Heather	SEFTON Leanne	THOMSON Kristine	WHITE Tonga
NGAWHIKA Richard	PUNCHEON Dean	SIMEON Maporika	THURLOW John	WHITE Tony
NIKORA Anthony	PUNCHEON Sharyn	SIMON George	TIMMS Dale	WHITFIELD Hilary
NIKORA Earl	PUNGA Allan	SIMON Keith	TINI Roimata	WILLEY Rex
NIKORA Michael	RAKENA Hapi	SIMON Mary	TIPENE Glenis	WILLEY Stuart
NIKORA Rachel	RAKENA Tatua	SIMON Mia	TIPENE Lillian	WILLIAMS Brandon
NUZUM Wendy	RAKENA Uru	SIMON Rahui	TIPENE Trevor	WILLIAMS Colleen
O'CONNOR James	RANGA Donna	SIMON Sharyn	TIPPING Sonya	WILLIAMS Danny
ODLUM SHANE	RANGA Hinemoa	SINGH Karen	TODD Anita	WILLIAMS Grant
O'HEARN Bryce	RANGA Rebecca	SINGH Peter	TODD Sonya	WILLIAMS Kim
OLIVER Ross	RANSFIELD Mero	SKETCHLEY Mary	TONGA Robyn	WILLIAMS Peter
OSBORNE Lenore	RAPANA Darren	SKETCHLEY Lillian	TORRINGTON Colin	WILLIAMS Tania
OSBORNE Rebecca	RARATA Alan	SMITH Barbara	TOTO Mark	WILLIAMSON Laurie
OWENS Geoffrey	RAUMATI Richard	SMITH Bruce	TOURNIER Michael	WILLIAMSON Michael
OWENS Joanne	RAWIRI Jonathon	SMITH Diane	TUKERE Marae	WILLS Murray
PAEKAU Anthony	RAWIRI Peter	SMITH Keha	TUKERE Whiti	WILSON John
PAEKAU Aroha	RAWIRI Turu	SMITH Miri	TUKERE Wynae	WILSON Stuart
PAEKAU Chadwick	RENATA Campbell	SMITH Steven	TURNER Lincoln	WINCHCOMBE Grant
PAEKAU Lena	RENATA Jackie	SMITH Susan	TURNER Mihi	WINIKEREI Kathryn
PAEKAU Reuben	RENETE Dale	SMITH Tracey	TURNER Mutu	WOOD Gary
PAIKEA Michelle	REYNOLDS Maree	SMITH Wendy	TURTON Denise	WORKMAN Lynette
PAIKEA Patricia	REYNOLDS Tracey	SOLOMON Lisa	TURU James	YOUNG Trevor
PAKI Wainui	RICHARDS Tracey	SOLOMON Shane	TURU Raymond	ZIMMERMAN Andrea
PARATA Heta	RICHARDSON Sandra	STANNARD Warren	TYRIE Leanne	ZIMMERMAN Wendy
	RIDLEY Gary	STANNARD Yvonne (60)	TYRIE Michelle	



J. BELL

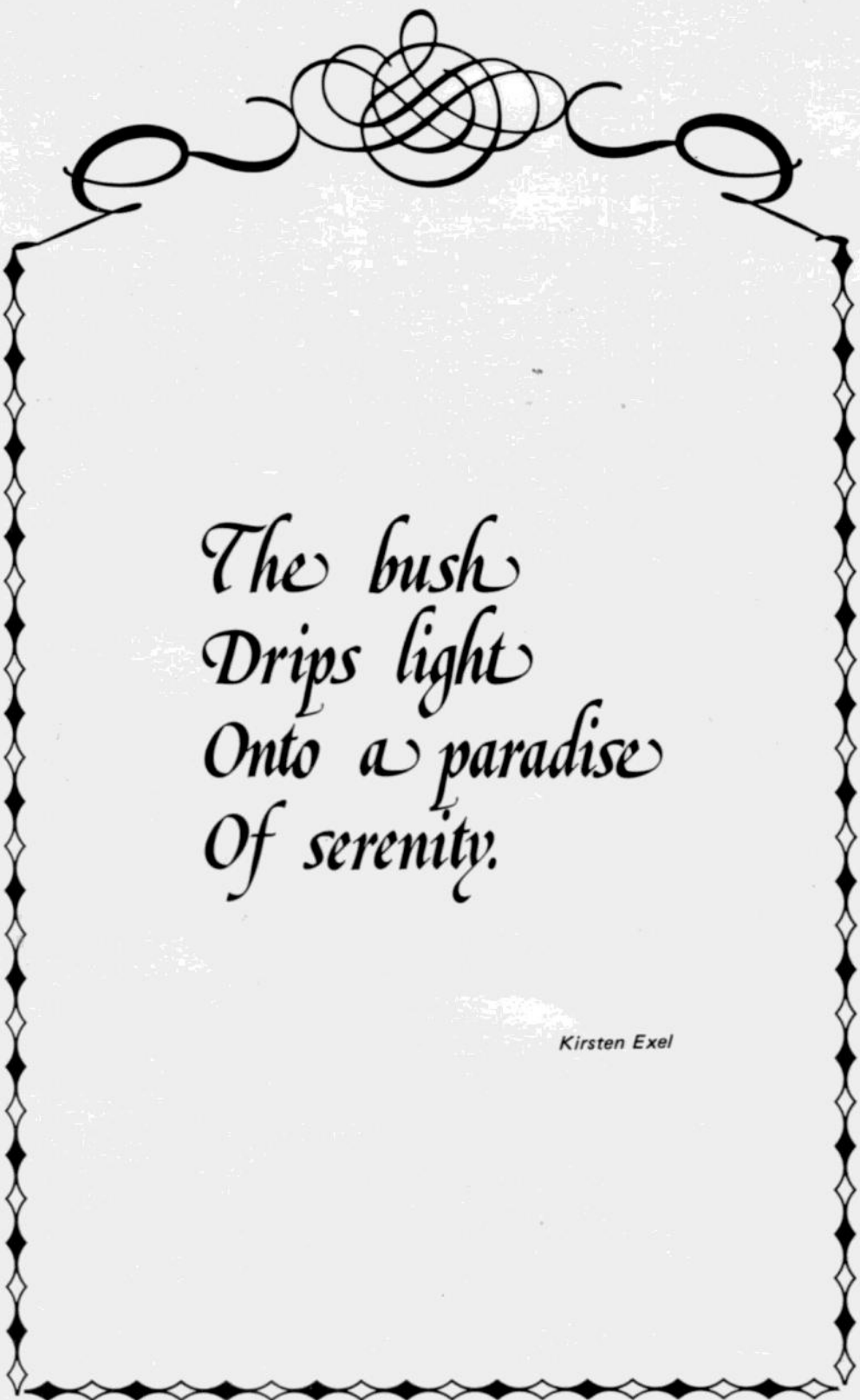

The bush
Drips light
Onto a paradise
Of serenity.

Kirsten Exel