

**NGARUAWAHIA
HIGH SCHOOL**

1980



ROBB



**WANTO
YOU**

EDITORIAL

Once again the year draws to a close and we have the pleasure of presenting to you yet another school magazine. Many layout changes have been made as you will see.

When volunteers were called together to work on the magazine committee we received overwhelming support from the 6th Form girls. Under Mr MacDonald's guidance we harassed pupils and staff until they finally gave us what we needed - reports of various activities. A raffle was organised to fund the magazine and this proved most profitable.

The most notable of the several new arrivals at school was our Deputy Principal, Mr Brian Robb. Several aspects of school routines were adjusted for a smoother staff/pupil relationship and administration. He has fitted into the school very well and we wish him the very best for the duration of his stay.

Our new school library looms large and empty in the centre of the school. Although finished some time ago, the library has not been opened due to minor interferences, and much to the seniors' regret as some of us will not have the chance of using it. I am sure this library will prove a valuable asset to the school and the community.

As usual, some mention must be made of the sports side of the school. The 1st XV did not do as well as expected this year but they did, however, provide us with some spectacular rugby. With some of the more notable Hamilton schools withdrawing from Secondary School rugby in protest of the 1981 Springbok tour, we may see our 1st XV holding that much desired trophy!

Hockey has made a great leap forward in popularity this year. Some outstanding players and teams proved too tough for the opposing teams and we won many fine trophies and awards in both the boys and girls divisions.

Altogether, the sporting teams have shown both skill and determination and have won against many bigger Hamilton schools. A truly commendable effort from all who participated.

Academically, we have not been lacking either. Future world leaders seem eminent amongst the hoard of school pupils. There is truth in the saying "If you can't dazzle them with brilliance, baffle them with bull!", as many of the teachers have found in some of the outspoken pupils.

Our sincere appreciation goes out to all who contributed to this magazine and to all pupils who sold raffle tickets on our behalf.

We wish you a very merry Christmas and a prosperous New Year.

Elaine Van Houtte

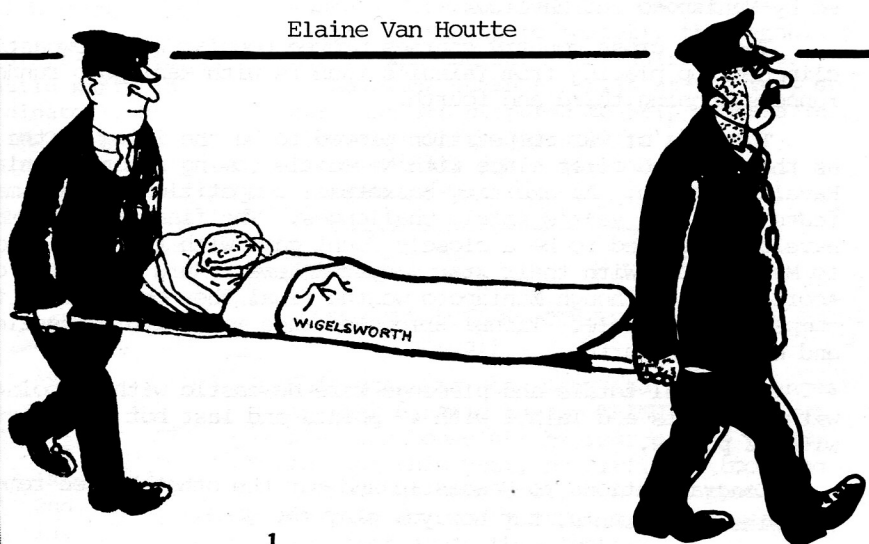

THE ULTIMATE AWARD

THE FOUNDERS SHIELD

For the past two years Newcastle has hit top form in the obtaining and the holding of the Founders Shield. This year is no exception with Newcastle dominating the various inter-house competitions with Maniapoto and Havelock closely contending for second place, and Tainui, well, all we can do is wish them the best of luck for 1981.

Starting early in the first term, we saw Newcastle take out the swimming competition, followed by Havelock, with Maniapoto and Tainui filling in third and fourth places respectively.

The athletic sports proved to be another successful event for Newcastle with an easy win over Maniapoto and Havelock with Tainui fourth once again.

March came, and once more it was time for the gala day. With heads together, groups desperately sought after an activity which would attract the public's attention. Five thousand dollars was raised overall, three thousand of which was a raffle run by Maniapoto.

A visit from the blood bank gave Tainui the opportunity to move into third place for the first time this year. Newcastle realized that they weren't the only horse in the race as Maniapoto shared top place with them.

A collection for the I.H.C. helped Havelock to gain much needed points having come third in the Blood Donors with Newcastle once again taking charge and Tainui back to its usual placing.

In the Salvation Army appeal Maniapoto once more showed Newcastle that they weren't giving up without a fight and there was another draw for first place. Tainui was on the scoreboard this time ahead of Havelock.

The third and final community collection for the school this year was for Corso and once again Maniapoto drew with Newcastle. Havelock and Tainui came third and fourth again.

September came and the Blood Bank returned and this time Newcastle had returned to top spot solo, with Tainui rising to the occasion to obtain second place followed by Maniapoto and Havelock.

The new cross country courses proved popular with Newcastle runners who clinched top placing from Tainui's runners with Maniapoto runners and Havelock runners runners running third and fourth.

The tugs of war competition proved to be the icing on the cake for Tainui as they claimed first place with Newcastle coming second, Maniapoto third and Havelock fourth. An exciting basketball competition was the main feature of this year's shield challenges. The final between Maniapoto 2 and Havelock 4 proved to be a closely fought game with the final score being 24 - 16 to Maniapoto. With their star player Hekewaru Muru scoring 10 of the 12 goals scored. But although Maniapoto won the final they only gained third place in the competition overall. Tainui triumphed once more with Newcastle coming second and Havelock fourth.

The final totals and placings were Newcastle with 86 points Maniapoto with 52 points and Tainui with 47 points and last but not least Havelock with 42 points.

Congratulations to Newcastle and may the other houses remember that it isn't who wins that counts, but how you play the game.

VICTORY yet again!!

3

HAVELOCK REPORT

WHAT A YEAR IT HAS BEEN FOR NEWCASTLE!!!!
The growth started in 1977 when Dave Sneddon (House Co-ordinator) established a sound foundation for House Spirit. But some hanky-panky we didn't win that year but came close and demonstrated in the ensuing three years what it was all about.

1978 and 1979 saw Newcastle scream into prominence and take the Founders' Shield both years; and then the new decade came along to match the new Newcastle image. Twelve firsts out of 13 activities was not to be sneezed at!!

Although we were compelled by some quirk of fate to share the limelight occasionally we did so in good grace (and much to the delight of other Houses!). Having three Groups in the Basketball Plate semi-finals and two in the final was a feather in our collective caps (N1 30 v. N4 20).

Competent Leadership was very evident in the House, ably illustrated by Waata Muru, Raymond Connolly, Shelley Campbell and Maggie Taylor. Besides individuals, group spirit was much in evidence as illustrated by N.1 (highest average income in Beef Raffle; winner B.B.Plate), N.2 (highest total income Beef Raffle).

Much can be said about individual efforts through the year, but their names can be frequently seen amongst the Awards and prizes. Joanne Loveridge as Head Girl, Shelley Campbell as American Field Scholar, Raymond Connolly as Spirit of Adventure participant are but the tip of the talented iceberg that is Newcastle.

Seven dedicated Newcastle Staff-members have played their enthusiastic parts in 1980: Mrs Middleton (Co-ordinator), Mr Grinter (N.1), Mr Philips (N.2), Mr Mains (N.3), Mr MacDonald (N.4), Mrs Ashby (N.5) and Miss Moore (N.6).

1980 PERFORMANCES:

IHC Collection	1st
Salvation Army Collection	1st=
Corso Collection	1st=
Swimming Sports	1st
Athletic Sports	1st
Gala Day Funds	1st
Blood Donors March	1st=
Blood Donors September	1st
Cross Country	1st
Tug of War	2nd
Beef Raffle	1st
Basketball Competition	1st=

The '80s began with Havelock continuing its unchallenged reign as the most imaginative, enterprising and exciting House in the school!

Commencing with the School Athletics meeting, where Havelock athletes stunned the crowds with unsurpassed performances in their events and the charming "Cheer-Bunnies" group adding a carnival atmosphere to the day, right through to Havelock members modestly receiving awards at the end-of-year prize-giving, this House was truly -----! (There is no word to describe them).

It's leaders, George and Sheryl displayed a flamboyant and dynamic style in driving House members towards many glorious achievements. Another leader (Havelock members are all leaders!) Quentin, took command at the helm of the whole student body and steered the school through many rough passages.

If one peruses the year's events one may notice Havelock occupying last place in the Tug-o-War. Brute strength has never been Havelock's forte. One only had to view two members, Greg and Craig, displaying their cultural and theatrical skills in the school play to recognise the fields where our talents lie (playing the roles of two dynamic teachers is a most difficult task!).

Finally, special mention must be made of Glenn, whose sporting abilities and good looks brought him the trophy of best senior boy in sports. He however displayed a trait which Havelock members are all known to possess - support and kindness to others. In his own unselfish manner, Glenn guided and coached his sister (a Maniapoto member), thus enabling her to win the best sportsgirl trophy.

Havelock members, while at the top, do care and are prepared to help members in the other three "struggling" houses. Thank you all for a one-sided but enjoyable year.

TAINUI REPORT

MOTTO: "WE FOLLOW, OTHERS LEAD" (Soon to be changed!)

This year has seen many startling changes in that dynamic house, TAINUI. Many have seen our house at the rear of the field, but not this year, no sir!. For too long Tainui has been last, and this past year we were very proud of doing well in other areas than looks!

Under careful control of that booming voice of Mr Sarjeants, Tainui picked itself up off the floor and took a flying leap. In competitions such as Athletics, Swimming, Raffles, Work Day, Gala Day and Crosscountry, Tainui was placed a notable fourth! But to the astonishment and sheer unbelief of the other three Houses Tainui was placed first equal in the Indoor Basketball and had a major win in the inter-House Tug-O-War competition (the result of irresistible forces meeting an immovable object).

Mention must be made of our own Pool Champion, Mr Meadowcroft. Along with Mr Mans (who was often there as a back-up in case Mr Meadowcroft needed him during the Doubles!) he won a trophy for the Staff Doubles Pool Player.

So Newcastle had better watch out as they have witnessed only some of Tainui's skill and determination. We may not have won the Founders' Shield this year but in future years - who knows?

Remember - We are Strong,
We are Invincible,
We are TAINUI!

YOUR HOUSE WITH MOUSE

An Inter-House Horrorscope

NEWCASTLE Your luck cannot last another year, unless you are prepared to work harder. Lucky colour is Yellow. Lucky number 1.

MANIAPOTO You are at the beginning of a "down" in your life, but, because of Saturn being in conjunction with Mars you have the potential of making a

4 FOUNDERS' SHIELD COMPETITION 1980

ACTIVITY	H	M	N	T
I.H.C. Collectors	2nd	3rd	1st	4th
Salvation Army Collectors	4th	1st=	1st=	3rd
Corso Collectors	3rd=	1st=	1st=	3rd=
Swimming Championships	2nd	3rd	1st	4th
Athletic Championships	3rd	2nd	1st	4th
Gala Day Fundraising	2nd	3rd	1st	4th
Blood Donors (March)	4th	1st=	1st=	3rd
Blood Donors (September)	4th	3rd	1st	2nd
Cross Country	4th	3rd	1st	2nd
Tug of War Competition	4th	3rd	2nd	1st
Indoor Basketball Comp.	3rd	4th	1st=	1st=
BEEF Raffle	3rd	4th	1st	2nd
FINAL STANDINGS	4th	2nd	1st	3rd

dramatic comeback in '81.
Lucky Colour Green. Lucky number 2.

TAINUI The Planets have graciously looked upon your efforts this year and you have commenced your comeback as contenders for the Founders' Shield. Colour red. Number 4.

HAVELOCK 1981 will see you rise, and then fall to a better house. Colour Blue. Number 3.

GENERAL PREDICTIONS 1981

By the year 1982 Newcastle will not be leading but, for the first time in many years, be trailing another contender. This contender will be Tainui, whose rise will coincide with the conjunction of all the planets in '82. Strange things will be in evidence on campus during '81 revolving around perplexing stirrings of the Tainui machine.



EENY, MEENY, MINY, MO!!!

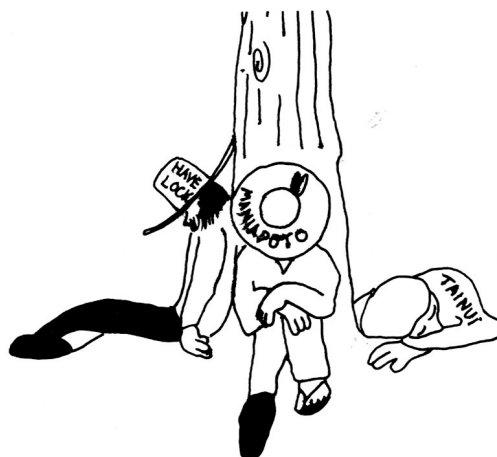

Inter-House 5

INTER-HOUSE TUG OF WAR RESULTS

	H3	H4	M4	M6	N1	N2	N3	N4	N6	T1	T2	T3	T4	T5	T6	Total Wins
H3	-	-	0	0	0	3	0	0	3	3	0	0	3	3	3	18
H4	-	-	0	1	3	0	0	0	1	0	0	0	1	1	3	<u>10</u> 28
M4	3	3	-	-	2	3	1	0	3	2	3	0	3	2	3	28
M6	3	2	-	-	3	3	0	3	3	3	3	3	3	3	3	<u>35</u> 63
N1	3	0	1	0	-	-	-	-	-	3	3	1	1	3	0	15
N2	0	3	0	0	-	-	-	-	-	0	0	1	1	1	0	6
N3	3	3	2	3	-	-	-	-	-	3	0	2	3	3	3	25
N4	3	3	3	0	-	-	-	-	-	1	2	2	2	3	0	19
N6	0	2	0	0	-	-	-	-	-	0	0	0	0	0	0	<u>2</u> 67
T1	0	3	1	0	0	3	0	2	3	-	-	-	-	-	-	12
T2	3	3	0	0	0	3	3	1	3	-	-	-	-	-	-	16
T3	3	3	0	0	2	2	1	1	3	-	-	-	-	-	-	15
T4	0	2	0	0	2	2	0	1	3	-	-	-	-	-	-	10
T5	0	2	1	0	0	2	0	0	3	-	-	-	-	-	-	8
T6	0	0	0	0	3	3	0	3	3	-	-	-	-	-	-	<u>12</u> 73

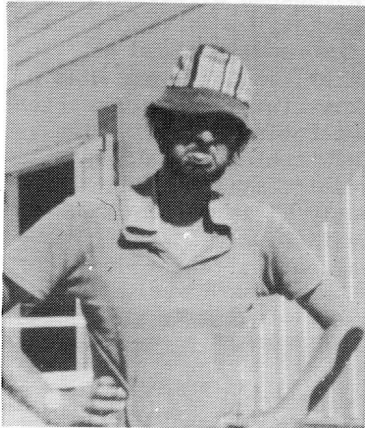

BASKETBALL PLATE

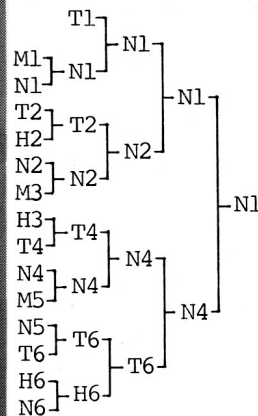

BASKETBALL CHAMPIONSHIP

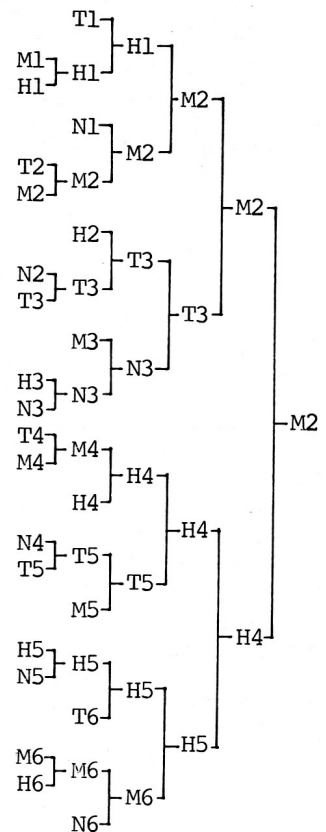

ROGER LITT



An ex-pupil of our school made it to the Waikato Provincial Rugby team this year. Roger Litt, Waikato full-back, attended Ngaruawahia High School between 1966 and 1970. We asked him about his memories of his school days. He said the school hadn't changed apart from a few additional classrooms, the gymnasium and the library. He remembered bringing an egg a day to school to help raise funds for the gymnasium!! Roger reached the sixth form but like most of us, wasn't too keen on the curriculum contents! His favourite subject was history. Roger had praise for Mr Murphy who was his English teacher and also his 1st XV coach. He played as 1st and 2nd five eight in the Ngaruawahia High School 1st XV team along with Chris Grinter, of whose Rugby talents he spoke highly. He remembers being caned by Mr Templeton! Apart from rugby and girls he liked tennis and cricket.

We then asked him of his experiences in the Waikato Provincial Rugby team, with special reference to the Ranfurly Shield matches. He said there was a lot of pressure within the team and nervousness was a big problem. Roger has to be relaxed before he can play a good game. He attributes the Waikato team's success to their good team spirit and their will to win. As with all successful sportsmen, Roger is aiming for higher goals. Who knows we may soon see him in All Black colours!

We ended the interview on a more controversial note and asked him his views on the proposed Springbok tour in 1981. He feels sport should not be mixed with politics and hopes the competitive merit of the tour will be considered in the final decision. On behalf of the school, Roger, best wishes for your future.

6 Rugby League Under 15yrs New Zealand National Representative

I started playing Rugby League at the age of seven for my home Club Turangawaewae, my position being Centre.

In 1980 an Under-15 Waikato team was selected for a National Tournament to be held at Davies Park, Huntly in the August holidays. Shane Pompey, Joseph Heremaia, Keith Simon, Mark Simon and myself were in the team.

This was a week of hard, solid football, during which a Northern Zone team was picked and I was selected. We were matched against a Southern Zone team, and from both squads a National team was picked. I found myself fortunate enough to play Centre as selected to face three Tests against New South Wales; one at Huntly and two at Christchurch.

The first test was close and we just lost. Then the squad flew down to Christchurch to play the second test on a Wednesday night - it was a thriller! The crowd there was amazing, filling both grandstands. The match could have gone either way in similar fashion to the first test, but Australia managed a last-minute try to clinch the series.

The team and I were determined to win the last encounter, which we did with the aid of the weather (as many of you would have seen on television).

Representing New Zealand was a great honour for myself, my parents and team-mates. But mostly I'll never forget the day I put on my first Kiwi jersey!

No reira, tena koutou, tena koutou, tena koutou katoa.

- HEKEWARU MURU



DRAMA

7

This year, under the direction of Mr Serjeant, the school Drama Club presented John Dighton's farce "The Happiest Days of Your Life". The play was performed on three nights to rather small audiences who nevertheless enjoyed all the mixed-up situations which developed when a boys' school and a girls' school were forced to share the same building.

The set was a good one, built by Mr Clayton, Mr MacDonald and Mr Bailey with the scenery painted by Miss Moore. Costumes were organised by Mrs Wardell.

A comment from a member of the cast - "After many hours of chaotic rehearsals we finally managed to get our play into a presentable form".

Our scheduled final dress rehearsal was so unco-ordinated that we thought we might have to cancel our first performance which was only two nights away. Our stage manager was so disgusted he was only too ready to swing on the end of a looped rope!

I don't know how our producers managed to pull us out of the mess we were in. Mr Serjeant worked overtime to keep us going, even to the extent of losing his voice from his "gentle persuasions". Mrs Schaare gave up her lunch-hours to give us a bit more coaching and we are sure she didn't know what she was in for when she took up the job.

Mr Clayton had a difficult task set before him when he became our stage manager. He made sure we all were on stage at the right time; even the winner of "missing the most cues", John Thurlow!

Our prompts were much appreciated as they had a full-time job. We thoroughly enjoyed the play thanks to our producer (and the rest of the off-stage team) who must have had a limitless supply of patience to revive a play which at times seemed to have one foot in the grave.



CAST

Dick Tassell	Craig Gutry
Rainbow	John Thurlow
Rupert Billings	Greg Bradshaw
Godfrey Pond	Dale Timms
Miss Evelyn Witchurch	Judith Hartstone
Miss Gossage	Michelle Pellow
Hopcroft Minor	Rodney Gutry
Barbara Cahoun	Wendy Gibb
Joice Harper	Wendy Nuzum
The Reverend Edward Peck	Lance Callaghan
Mrs Peck	Sandra Robertson
Mr Sowter	Gary Ridley
Mrs Sowter	Shelley Campbell



Producer	J. Serjeant
Associate Producer	J. Schaare
Stage Manager	J. Clayton
Set Construction	A. MacDonald
Set Painting	J. Moore
Properties	R. Bailey
Prompts	Glennis Runciman
	Carey Bullen
Business Manager	R. Wigelsworth
Front of House	Susan Sharp
	Carol Crawford
Programme	J. Storey
	6th form typists
Lighting & Sound	Quentin West
	Raymond Connolly
Costumes	J. Wardell
Make-up	J. Schaare
Programme Cover	Rodney Gutry
Usherettes	Leanne Sefton
	Sonya McBurney
	Bronwyn Thurlow
	Sheree Parker
	Tracey Campbell
	Glennis Runciman
	Linda Mills

Rotary Exchange Student

Shelley Campbell, along with several other senior students went for their first interview at school where she was told about the financial requirements of a Rotary Exchange Student. This whittled the candidates down to three - Michelle Fellow, Dale Timms and Shelley. The next assignment was to prepare themselves for an interview by the Rotarians at Dunlop along the Te Rapa straight. There they faced a panel of three men and one woman who directed many questions at them.

At 10 o'clock the same evening Shelley received a telephone call asking her to attend a further interview on the following Wednesday. There she was asked many different additional questions, one about the N.Z. Government which she was unable to answer.

However, this question didn't seem to matter as she was contacted by 'phone at 10 o'clock that night and informed that she had been selected as a Rotary Student. It was a time for celebration in the Campbell household and so the champagne glasses were brought out!

8

Then came the time for attending Rotary Conventions with private introductions of Rotary members, and generally getting the feel of what Rotary is all about. Shelley recently attended an orientation meeting in Rotorua, where students from both N.Z. and overseas got together to discuss conditions overseas and in N.Z. They stayed at a Rotorua Marae where many relationships were formed with interesting people.

On the 6th of November Shelley found out just where she was headed. She is destined to spend the next year at Plano, Illinois. Excitedly looking forward to 1981, Shelley thanks the school for providing her with such a fantastic opportunity.



THE SEVEN DEGREES

The group, known as Septic at this year's variety concert, started as a four piece group which travelled to Tauranga, early this year, to perform at a concert where they were commended.

Recently more people have joined the group which now has seven people. The group is now working with more popular songs in order to please their listeners. Donna Ranga, a member of 'The Seven Degrees' has composed a few songs such as "Down at the Cafe' Bar" and "My Lucky Number 3", on which the group are also working.

The people in the group are:
 Joseph Tahana (harmonica, synthesizer, glockenspiel, trombone)
 Michael Williamson (bass guitar)
 Murray Hintz (synthesizer, piano)
 Rodney Gutry (drums)
 Richard Wardell (guitar, vocals)
 Donna Ranga (clarinet, lead vocals)
 Lillian Sketchley (background and lead vocals)

TABLE TENNIS



REAR: L.Callaghan, L.Carrol, H.Lovell, E.Nikora, B.Harding.
 FRONT: R.Harris, R.Nikora, D.Ranga, D.Wade, Mr Samujh.

Unemployment, inflation, a high crime rate and drugs. Four major problems that confronts today's modern society. Four major problems that have got nothing whatsoever to do with my speech! Instead I am going to talk about something which I think is much more important and which concerns each and every one of us.

I am here on behalf of an organization called S.P.U.T., which stands for "The Society for the Protection of the Underprivileged Toilet", and the main reason that I am here is because we are rather disconcerted at the lack of care and interest shown by you towards the toilet.

The Toilet - a symbol of grace, elegance and beauty. Unobtrusive, practical and yet essential, it is a piece of apparatus which sits there devoid of all emotions. Its rounded, beautifully moulded figure is both firm and inviting. Its strong, sturdy body capable of weathering the most violent of attacks! To a person in time of need the toilet can be a God-sent blessing, and for as long as man can remember, it has served him well.

Yet the toilet is still subjected to continual abuse and harrassment. For example: we have people calling the toilet by such undignified titles as "the loo" or "the lav" or "the outhouse", and I'm only too glad my mummy and daddy didn't name me John!

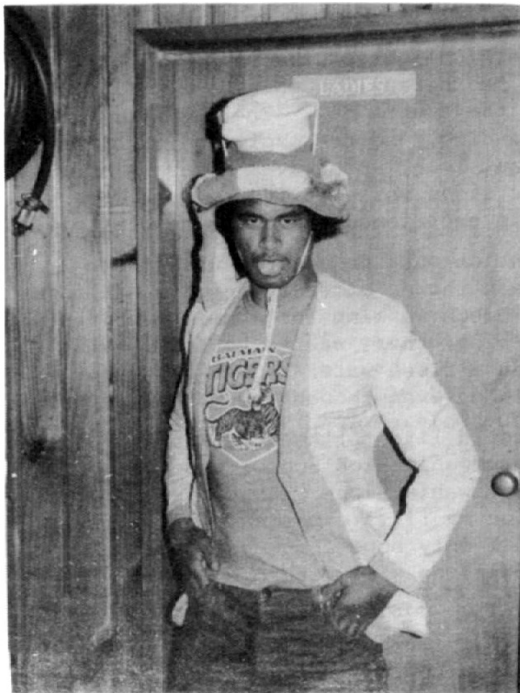

However, what I feel is even more disconcerting, is the fact that more and more people are beginning to lose the art while in the toilet - an art handed down from generation to generation - an art preserved through the catacombs of history.

Today, 95% of the population go to the toilet, rush through their task as if there were no tomorrow, complete the formalities, then get the hell out of there as quickly as their little feet can carry them. However, the other 5% are what you could term pure artists. This 5% appreciate perfection and take pride in their effort and hence you will find that whenever this 5% go to the toilet, they approach their task in a much more relaxed state of mind and 9 times out of 10, come out of the toilet with a huge smile on their face knowing full well a job well done.

This brings me to my next point, I wonder how many times have you been caught in the somewhat embarrassing situation of not having any toilet paper at the completion of your effort.

Imagine this situation. You have been sitting there for over an hour. You are both physically and mentally dehydrated. You feel you have done your best so you reach for the toilet paper. But alas! Your hand grasps at thin air. No toilet paper. You begin to get desperate. A frantic search of the toilet reveals that there is definitely no more toilet paper. You are trapped, helpless, stranded, on the verge of panic. There is no turning back now for the damage has already been done. Eventually you realize that your only way out of this mess is to yell for help and imagine the embarrassment when you have to yell at the top of your voice; "Somebody bring me some toilet paper!"

And there you have it - the toilet. One of the most important things to mankind (apart from food, shelter and rugby). But, let's face it. You need the toilet and the toilet needs you!

POWER TO THE TOILET!!!

-George Simon.

"Some folks are wise and some are otherwise."
-Smollett

The Spirit of Adventure

The 'Spirit of Adventure', a ship not nearly as relaxing as an excursion vessel yet not so strict as a naval vessel. The sail training ship teaches New Zealanders the hardship and excitement of learning the ropes of a sailing ship.

A routine of being called in the morning at 6 a.m. for physical training (a slight jog around and press-ups) and then overboard for a swim at 8-10°C to awaken and cleanse the body. Breakfast at 6.30 a.m. Assembly on poop deck at 7:55 for the Colours (raising of the flag, 8 a.m. chime on the bell and the "Carry on" whistle). Dismissed to cleaning stations. The ship was cleaned every morning. Various different things happened each day after the ship was cleaned.

The crew on board consisted of 25 trainees, divided into 3 watches - Red, White and Blue - the Captain, Mr Nicklaus Hylton, 3 Watch Officers, a Cook, an Engineer and the Voyage Leader Geoff Sinclair.

Confined to the Hauraki Gulf meant very little to us. The Gulf is hardly a millpond! In ten days we had only managed to explore under half of the Gulf. In fact, little attention was paid to our travels, as long as we were experiencing the enjoyment of sailing, everybody was content.

Geoff who was a past trainee, (he was 20 years old), had the job of helping us to appreciate the necessity of order, sort out any problems and generally guide the trainees. He earned our respect; we even went as far as to decorate his cabin completely with toilet paper!

Much of the first three days was spent on lectures of importance in running a vessel. These necessary subjects included:- Safety features (Man-Over-Board Drill; Fire Drill; Distress Signals; Anchor Watch; Collisions), Navigation, Sail Training (Theory),

Maintenance and Meteorology. Although these lectures sound very boring they proved to be most helpful. The practical theory of these lectures were at times very amusing!

Such adventures as A Man-Over-Board Drill to save a hat in distress, which had been caught by a gust of wind; a Fire Drill in the Mess Deck while the fire hose was taken to the Bridge; and my disaster of unbalancing one small, fibre glass training yacht while boarding it (amazingly the water was wet!!)

Unfortunately for me, my sleeping accommodations were not the best. At three stories high, an opening of two foot by four foot to climb in to, a roof decline in the aisle (which occasionally left a few marks in my back) and a leaking skylight in bad weather. This did not, at all, reflect upon the facilities. My bunk was the only one in an awkward position to get in to and my size didn't help much either. This problem is to be corrected in the 'Refit '80' though. The six wooden bunks are to be replaced by folding, steel frame bunks.

The highlight of the trip would have to be the sailing on a 25-27° slant on the fourth day. The awkwardness of standing, and the excitement of a constant lean, with waves spraying over the sides while trying to work made this experience even more memorable.

Mention must be made of our first fresh shower after seven days sailing. Although we went for a swim every morning, there was no better feeling than a fresh water shower on Kawau Island (even though the water was cold!).

I would like to thank Mr Murphy, the Ngaruawahia High School and the Ngaruawahia Lions Club for sponsoring me on my first experience of sailing and I only hope that the opportunity of sailing will return someday.

Raymond Connolly



The Art of Barefoot Water Ski-ing is the ultimate aim of every water skier. This means stepping on to the water on barefoot and skimming along at high speed. Rodney has achieved this goal and is now concentrating on tricks on the water e.g. tumble turns, rope on neck, one foot, rope in teeth and many many more.

Rodney Gutry has belonged to the Ngaruawahia Water Ski Club for the past four years, and has moved into display demonstrations as the top man on the three and six person pyramid, where at last he can look down on the world. Basically the club is a fun club, but a visit from the New Zealand Barefoot Coach and Selector encouraged Rodney to have a go at barefooting and competition. Initially he tried barefooting with his old 'Charlie Blacks', which now hang up in the club shed.

Four months after first stepping off his skis onto the water he was to be placed

- 1st Junior Boy Start Methods
- 1st Overall Waikato Skier Junior Boys
- 1st Waikato Skier Junior Boys tricks
- 1st Waikato Skier Junior Boys Wake Slalom

and a few others at the Waikato Regional Championships held at Piarere Water Ski Club on 2nd March 1980. With encouragement from a senior examiner Rodney was told to have a try at the New Zealand National Barefoot Championships to held at Wairoa, Hawkes Bay - these were later to be transferred to Atiamuri after shocking weather and unsafe water conditions.

A week later Rodney came home with his New Zealand Bronze Medalion for Junior Boys Start Methods. Rodney has plenty of work to do with only two seasons left in the Juniors.



Caroline Pritchett



Richard Wardell



Paul McMillan

WAIKATO REPRESENTATIVE

This year the school was fortunate enough to have one of our hockey girls accepted for a Waikato Hockey Association Representative Team.

Tracey Smith was selected out of hundreds of girls to play in the Waikato 'D' team. She firstly played in Auckland in a very worthwhile and rewarding game. She represented the school proudly and showed her skill in the game of hockey, turning the eyes of many very important members of the hockey association.

She was also selected to play in the Waikato Secondary School Girls 'B' team, at Innes Common, Hamilton.





THE COMMON-ROOM CUTIES

BACK ROW:- Left to Right

Shane Solomon, John Thurlow, Robert Hodgkinson, Robert Wright, Raymond Connolly, Quentin West (Head Boy), John Sayers, Martin Van Tiel, Robert Van Woerden, Grant Johnston, George Simon, Greg Bradshaw.

4th ROW:-

Michael Pokaia, Dale Timms, Angela Bright, Jackie Black, Sheryl Dyson, Judith Jennings, Susan Sharp, Glen Solomon, Waata Muru, Susan Smith.

3rd ROW:-

Scott Schrieber, Graeme Collis, Craig Gutry, Kim Te Wiata, Dale Barakat, Loryn Lovell, Dorothy Callaghan, Venita Carswell, Maria Prendergast, Neroli McIlraith, Debbie Prince, Megan Barlow, Judith Hartstone, Rachael Nikora, Mr Sargeant.

2nd ROW:-

Shelley Campbell, Leanée McPherson, Mahinarangi Hopa, Joy Waters, Ata Heremaia, Joanne Loveridge (Head Girl), Maggie Taylor, Leanne Tyrie, Elaine Van Houtte, Helen Jennings, Carol Crawford.

FRONT ROW:-

Robyn Harris, Valerie Brown, Dorothy Derecourt, Sandra Robertson, Michelle Pellow, Karen Frater, Heather Dooley.

STAFF

Much is recorded in school magazines of the achievements of the students - little is said of the staff. During the lunch-hours and after school many of the staff members have been sweating slavishly over a hot pool table in the annex of the staff-room. A doubles competition was held over several weeks and the results are as given:

Wigelsworth/MacDonald	4 wins
Grinter/Clark	4 wins
Esselbrugge/McIntosh	3 wins
Meadowcroft/Mans	5 wins
Johnston/Clayton	2 wins
Serjeant/Cargo	1 win
Paurini/Samujh	5 wins
Bailey/Philips	4 wins

Mr Paurini and Mr Samujh had an equal number of wins but were beaten on the countback as they had suffered a defeat at the cues of Meadowcroft & Mans.

S BLUE SCIENCE



Looking less like a yacht
And more like a barge
Is the H.O.D. Science;
That's our teacher, 'Sarge'!



"Come inside," he calls out,
"And be quiet, please."
But Tracey and Linda
Still yak with Louise



"Come inside. Come inside,
And to work in a hurry!"
But Kerry and Gary
Are beating up Murray!



And down at the back
Trying to act like the boss
Is the big rugby hero -
"The wee baby, Ross".



While Brandon is late
Saying 'bye' to his girl;
With his mind in a daydream
He sits down by Earl.



And down at the back
Sits young Justin West -
He's thinking of rugby,
So he can't do his best.



It's somebody's birthday:
Who is that "well-wisher"?
Throwing perfume and powder?
It has to be Fisher!



A superball bounces
With orbit quite bendy.
You can guess who's the owner
The Superkid, Wendy.



And sitting nearby
And trying to act cleverly
Is the Glen Massey sweetheart
The young little Beverly.



With her mind not on Science
As she dreams of her horse
Is the Head Girl's young sister
Fiona, of course.



With no work in her book
But a smile on her lips
Would our Helen's face
Launch one thousand ships?



Caroline, Nicole
And friend, Linda Scott;
Are they sitting there working?
No! They are not!



Robert is trying,
And so too is Trish,
But chaos surrounds them
And they don't get their wish.

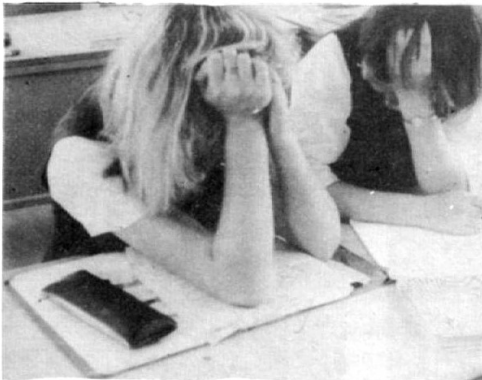

Shelley just sits there
As she leans over to tell
Her plans for next weekend
To friend Raewyn Bell.



In the South-Western corner
There stands Sharyn Puncheon,
Thinking much less of Science
And more of her luncheon!

We're a great bunch of people full of cheek and defiance;
And we're all good at something - but it sure isn't Science!

<u>EVENT</u>	<u>Jun.Boys</u>	<u>Int.Boys</u>	<u>Sen.Boys</u>	<u>Jun.Girls</u>	<u>Int.Girls</u>	<u>Sen.Girls</u>
100m	1. J.Hona 2. R.Salt 3. D.Lauder	R.Wall H.Muru R.Liddell	I.Thackray G.Bradshaw Q.West	P.Thackray D.Vincent S.Todd	L.Park T.Roe V.Head	C.Fletcher D.Prince J.Loveridge
200m	1. J.Hona 2. R.Salt 3. D.Lauder	R.Wall H.Muru J.West	G.Solomon Q.West -	P.Thackray J.Plummer S.Todd	L.Park D.Turton V.Taylor	C.Fletcher J.Loveridge D.Prince
400m	1. J.Hona 2. P.Hodgkinson 3. A.Lewin	R.Wall S.Johnston P.McMillan	I.Thackray M.Hintz J.Henry	J.Plummer D.England S.Todd	L.Park V.Head D.Turton	H.Jennings R.Davies K.Parker
800m	1. P.Hodgkinson 2. L.Henare 3. J.Bradshaw	P.McMillan B.Beetham S.Johnston	M.Hintz R.Connolly R.Cairns	J.Plummer L.Gurnick T.Paieka	L.Park T.Roe S.Parker	D.Barakat M.Prendergast R.Davies
1500m	1. A.West 2. P.Hodgkinson 3. L.Henare	P.McMillan D.Brown S.Johnston	R.Connolly R.Hodgkinson R.Cairns	- - -	L.Park T.Roe C.Davis	D.Barakat P.Clark S.Robertson
100m Hurdles	1. R.Salt 2. R.Paekau 3. J.Bradshaw	H.Muru S.Graves D.Miller	S.Solomon M.VanTiel G.Solomon	P.Thackray K.Thomson R.Comins	V.McCarthy C.Davis W.Nuzum	C.Fletcher R.Harris A.Smith/S.Dass
Shot Put	1. W.Waters 2. H.Rakena 3. M.Kaio	A.Paul P.Andrews R.Wall	R.Katipa G.Simon H.Katipa	D.Vincent A.Baird W.Tukere	M.Tini A.Middleton R.Parata	L.Clay V.Brown S.Smith
Discus	1. M.Toto 2. D.Lauder 3. R.White	B.Williams M.Williamson S.Graves	I.Thackray G.Simon M.Pokaia	S.Tahana K.Maxwell D.England	J.Jennings A.Morunga V.Head	L.McLean D.Wade S.Robertson
Long Jump	1. R.Paekau 2. A.West/ D.Lauder/ G.Fletcher	B.Harding/ S.Whatford H.Muru	G.Bradshaw G.Solomon G.Cathro	D.Vincent K.Thomson A.Jacobs	V.Head J.Jennings/ M.Essel- brugge	L.Clay J.Loveridge/ S.Dass
Triple Jump	1. R.Paekau 2. K.Morgan 3. K.Robertson	R.Wall H.Muru Hekewaru Muru	G.Bradshaw G.Solomon G.Johnston			
High Jump	1. M.Kaio 2. K.Morgan 3. R.White/ O.Allison	J.Bell B.Williams B.Harding	G.Cathro G.Bradshaw R.Connolly	B.Bailey P.Thackray K.Thomson	V.Taylor T.Roe S.Vittle	V.Solomon J.Loveridge S.Dass
Javelin	1. R.Salt 2. R.White 3. D.Williams	P.Andrews B.Harding L.Turner	B.Windsor M.VanTiel M.Pokaia			
<u>CHAMPIONS</u>	1. R.Salt 2. J.Hona 3. R.Paekau	R.Wall Huranui Muru P.McMillan	G.Bradshaw I.Thackray G.Solomon	P.Thackray J.Plummer/ D.Vincent	L.Park T.Roe V.Head	C.Fletcher L.Clay/ D.Barakat
Relays	1. Havelock 2. Maniapoto 3. Newcastle	Maniapoto Newcastle Havelock	Havelock Maniapoto Newcastle	Tainui Newcastle Maniapoto	Newcastle Maniapoto Havelock	Newcastle Tainui Maniapoto

ATHLETICS

"It is impossible to enjoy idling thoroughly unless one has plenty of work to do."
-Jerome

VOLLEYBALL

16

4TH FORM

This year a Volley Ball Competition was held at the Tauranga Youth Centre, so Mr Paurini thought of entering his 1979 third form team who this year would be fourth formers.

We practised for long hours wanting to do our best in Tauranga. The team is as follows:

Peter Rawiri, Hekewaru Muru, Steven Paul, Martin Ryan, Pierre Clarke, Steven Johnston and Reuben Paikea. Volley ball uses six players and when Reuben Paikea was unable to make the trip to Tauranga the boys were not too set on playing without substitutes but played with good results.

We stayed at Mr Paurini's Thursday night having to catch our bus early Friday morning. Boy! what a slave driver he practically made us vacuum clean his weeds. We mowed the lawn, weeded his gardens, but got a good meal for our help from Mrs Paurini. Because of the excitement none of us boys got to sleep till the early hours of the morning.

At Tauranga we were billeted out and we all were treated well and thanked them gratefully.

The result of the competition was we won 3 out of 6 games eventually winning the B grade. We would like to thank Mr Johnston who transported us to and from Mr Paurini's place. We also thank Mr Paurini for being a great coach.

By Bouffy Paul and Peter Rawiri

Athletic Zone Results:

Sarah Tahana - 4th Jnr girls javelin
 Jan Plummer - 2nd Jnr girls 800m
 2nd Jnr girls 400m
 Caroline Fletcher - 3rd Snr girls 100m
 2nd Snr girls 100m
 hurdles.
 Dale Barakat - 1st 800m Snr girls (NR)
 1st 1500m Snr girls
 Vivienne Taylor - 4th Int girls high jump
 Judith Jennings - 4th Int girls discus
 Paula Thackray - 3rd Jnr girls 100m
 2nd Jnr girls 200m
 4th Jnr girls 100m
 hurdles.
 Donna Vincent - 4th Jnr girls 100m
 Valerie McCarthy - 4th Int girls 100m
 hurdles.
 Paul McMillan - 3rd 3000m Open
 John Bell - 4th Int boys high jump
 Ross Wall - 1st 100m Int boys
 1st 400m Int boys

Aaron West - 3rd 1500m Jnr boys
 Relay results - 3rd Jnr girls
 - 3rd Snr girls
 - 3rd Int boys

Results from the Waikato Cross-Country held at Te Awamutu:

Junior Girls - Leslie Gurnick (24th)
 Jan Plummer (69th)
 Donna England (74th)
 Intermediate Girls -
 Tracey Roe (14th)
 Natalie Hinton (54th)
 Wendy Nuzum (56th)
 Sheree Parker (retired injured)
 Junior Boys - Steven Chrystall (54th)
 Steven McLaren (65th)
 Intermediate Boys -
 Dean Brown (77th)
 Shane Comins (84th)
 Ricky White (85th)



REAR: P.Clarke, M.Ryan, S.Johnson, Mr Paurini.

FRONT: P.Rawiri, S.Paul, H.Muru.

vs Rotorua lost 13-15/ 7-15
 vs Whakatane lost 5-15/15-11/13-15
 vs Forest View lost 2-0
 vs Te Puke won 4-15/15-12/15-12
 vs Otorohanga won 15-13/ 7-15/15- 6
 vs Mt Maunganui won 15-11/15- 7
 (final B Grade)

This was a fine performance for a team with so little experience in competition games. The team acquitted itself well and was the most supported team at Tauranga with large galleries cheering on the "bush-mans" team. Hekewaru Muru and Peter Rawiri excelled themselves as games became more frequent often spiking the ball down the throats of their more experienced opponents. Well done team.

BASKETBALL

JUNIOR BASKETBALL

All four Junior teams did extremely well in the Waikato Secondary Schools' competition and produced a feast of successful basketball. The 3A girls were runners-up in their grade, the 4A boys were joint winners while the 4A girls were undefeated for the second year running, again winning their grade. The 3A boys were 6th and were unfortunate in losing some close games. A fine effort for such a small school, and a good base on which to build stronger teams in the future.

A lot of the credit goes to the amount of practice put in by the teams.

17 This year, with the talent so obvious, we had early-morning training (7am - 8:30am). It was heart-warming to find 26 young boys here at 7am and telling you you're two minutes late. At times it was so dark the flicker of a candle (or was it a cigarette) could be seen from the car-park, with the eager beavers wanting to get into the gymnasium.

The future looks bright for basketball providing the large number of pupils leaving is minimal. To all the players I say "Well done,"; to the parents who helped with transport and supported us - "Thank you kindly,"; and especially those that let their children out of bed so early to come to practices!

- A. PAURINI

3 A TEAMS

3A GIRLS BASKETBALL

Beaten only twice and drawing twice the girls performed well throughout the season. Practicing at 7am in the morning helped but there were some who needed a little persuasion to get out of bed.

Threatened with a fine of a dollar each for every practice missed, the girls found an incentive to be there. Mrs Paurini assisted her husband in the coaching of the team.

Individual talents came through in the games: Lisa Solomon's lay-ups, Wynae Tukere's long shots, Mero Ransfield's defensive hustle and Sarah Tahana's ball control all helped as match-winners.



REAR: A. Jacobs, W. Tukere, M. Turner, S. Tahana.

FRONT: Mr Paurini, L. Solomon, M. Ransfield, P. Harper, Mrs Paurini.

Competition Results:

3A v. Fairfield A	20- 3
v. Fairfield B	32- 8
v. C.C.N.Z.	11- 8
v. Melville	11- 8
v. Hillcrest	20-22
v. Fraser	12-16
v. H.G.H.S.	8- 8
v. Fairfield A	32- 2
v. Fairfield B	13- 1
v. C.C.N.Z.	10-10

Interschool Results:

3A v. Huntly	20-12
v. Hillcrest	21- 5
v. Huntly	21- 4

3A BOYS BASKETBALL

This squad was a very inexperienced one but provided a good broad base on which to work. They performed well over the season and learned well as they played.

Thanks go to the parents who supported and transported the boys. With a lot of work ahead in 1981 the team hopes to emulate the 4A squad and be established throughout the competition as a team to be reckoned with.

Competition Results:

3A v. Fraser B	15-0
v. C.C.N.Z.	5-30
v. Fairfield	6- 6
v. St Johns' A	8- 8
v. Melville A	4-24
v. St Johns' B	4- 2
v. Melville B	4- 5
v. Hillcrest	2-51
v. H.B.H.S.	12-0

Interschool Results

3A v. Huntly	22-13
v. Hillcrest	3-24
v. Huntly	9- 3



REAR: M.Clay, D.Pihama, Mr Paurini,
B.Matenga, C.McRoberts.
FRONT: R.Nelson, R.White, H.Parata,
J.Rakena.

8 4A BOYS BASKETBALL

This year's team was much the same as last year's. There were several minor changes with only three new-comers in Tatua Rakena, Karoria Morgan and Steven Paul.

A few injuries through the season upset the team's rhythm somewhat and Martin Ryan's commitment to the 2nd 15 Rugby team prevented him from playing a full season.

We had won every game in the competition until we came up against C.C.N.Z. in the last match and lost by one point but shared honours with Church College in winning the Waikato 4th Form Competition.

Hekewaru Muru was the highest scorer of the team, due to the excellent supporting play by his team-mates.

Competition Results:

4A v. St John's A	13- 2
v. Fraser	25- 8
v. H.B.H.S.	45-17
v. C.C.N.Z.	19-18
v. St John's C	36- 3
v. Hillcrest	26- 4
v. Melville	44-20
v. St John's B	25- 8
v. C.C.N.Z.	12-13

Interschool Results:

4A v. Huntly	44-20
v. Papakura	19-17
v. Hillcrest	47- 0
v. Huntly	30- 2

4A GIRLS BASKETBALL

Undefeated for two successive years! The girls played excellent basketball coached by Mr Paurini and Captained by Valerie McCarthy, also showing that early-morning practices (7am to 8:30am) paid off.

The good ball handling of Juanita Apiata, excellent lay-ups by Maude Tai and the defensive hustle of Connie Davis proved too strong for the opposition.

Acknowledgement is given to the parents who transported us and cheered from the sideline.

Competition Results:

4A v. Fraser	21- 6
v. C.C.N.Z.	17-12
v. Fairfield	20-10
v. Melville A	20-10
v. Hillcrest	14- 4
v. Sacred Heart A	26- 2
v. H.G.H.S.	16- 2
v. Fraser	20- 4
v. C.C.N.Z.	17-11
v. Fairfield	22- 8

Interschool Results:

4A v. Huntly	29- 7
v. Papakura	40-18
v. Hillcrest	8- 6
v. Huntly	47- 2

Winners of the Waikato Girls 4th Form Competition!



REAR: H.Nelson, C.Davis, Mr Paurini,
L.Tipene, M.Mahara.
FRONT: M.Paekau, M.Tai, V.McCarthy,
W.Apiata.



REAR: J.Heremaia, K.Morgan, Mr Paurini, S.Paul.
FRONT: T.Rakena, P.Rawiri, H.Muru, L.Turner.

SENIOR GIRLS BASKETBALL

The Senior Girls A Basketball team under the able leadership of Lorraine Vercoe were entered in the Premier Grade for Waikato Secondary Schools and performed well although not well enough to gain a place.

The team consisting of Lorraine, Carmen Haggie, Vicki Solomon, Jackie Black,



REAR: J.Panapa, M.Hopa, J.Black, Mr Bailey.
FRONT: A.Black, L.Vercoe, S.Simon, V.Solomon.

19 Adrienne Black, Julie Panapa, Sharon Simon and myself all played well throughout the tournament with some very good wins marred by losses, (which could have been avoided), due to mistakes made by all members of the team. The overall effect however did not do much to dampen the spirits of the team and I am sure they would like to thank Mrs Black and Mr Bailey for their coaching and supervision and responsibility for the team. Thankyou very much!

Mahinarangi Hopa

SENIOR BOYS BASKETBALL

The composition of this year's team was primarily of boys with little experience in Basketball and was accordingly entered in the Second Grade. A strong finishing run placed the boys 3rd on the table.

When available, Glenn Solomon was an outstanding player, well supported by Joe Tahana who defended vigorously and showed a deft shooting touch close to the basket. Another player to take the eye during the season was Huranui Muru, whose defense and rebounding skills were of great value.

Jeffrey Waters and Brandon Williams were out of contention most of the season through injury and their contributions were missed by the team. Fourth-former Hekewaru Muru filled in ably on occasions and looks a good prospect for the future.

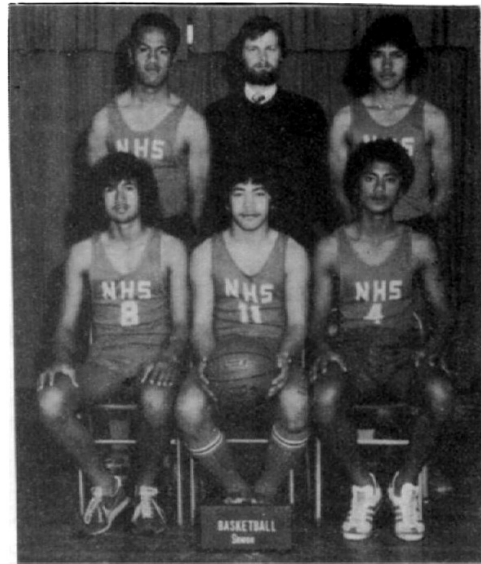

REAR: J.Tahana, Mr Meadowcroft, G.Solomon.
FRONT: P.Rawiri, J.Waters, H.Muru.

Cross country

JUNIOR GIRLS

1. J.Roe
2. J.Plummer
3. B.Bailey
4. L.Gurnick
5. S.Richardson
6. S.Houghton
7. P.Thackray
8. T.Richards
9. L.Kitto
10. M.Jeanes
11. H.Whitfield
12. V.Buchanan
13. M.Tyrie
14. R.Comins
15. A.Baird
16. S.Todd
17. J.Alan
18. G.Hartstone
19. J.Collins
20. L.Ridley
21. L.Langley
22. A.Powlesland
23. K.Perham
24. K.Thompson
25. S.Tancred
- 26= L.Rogers
K.Rogers
28. B.Law
29. E.Vandy
30. L.Meagher
31. M.Mahara
32. S.Gurmel
33. R.Menzies
34. L.Sefton
35. C.Nelson
36. M.Reynolds
37. F.Crowther
38. C.Docherty

INTERM. GIRLS

1. T.Rowe
2. S.Parker
3. N.Hinton
4. W.Nuzum
5. A.Matthews
6. M.Morgan
7. G.Runciman
8. V.Taylor
9. M.Esselbrugge
10. L.Park
11. J.Owens
12. H.Ringrose
13. T.Richardson
14. V.Head
15. T.Campbell
16. W.Hansen
17. A.Hopa
18. H.McLean
19. B.Hill
20. H.Lawry

21. L.Clay
22. R.Parata
23. R.Taylor
24. L.Osborne
25. D.Turton
26. S.McBurney
27. K.Doncaster
28. D.Sargent
29. I.Excell
30. M.Prince
31. V.McCarthy
32. F.McNally
33. C.McSweeney
34. G.Knight
35. L.Mills
36. L.Gurmel
37. D.LaGrand
38. L.Frater
39. T.Reynolds
40. B.Thurlo
41. T.Stephens
42. J.Dalbeth
43. B.Ashley
44. L.Geilen
45. L.Scott
46. A.Middleton

SENIOR GIRLS

1. C.Fletcher
2. V.Solomon
3. A.Bright
4. R.Nikora
5. S.Dass
6. R.Davies
7. M.Pellow
8. S.Robertson
9. M.Prendergast
10. D.Wade
11. R.Harris
12. M.King
13. L.Vercoe
14. D.Prince
15. M.Barlow
16. F.Marwick
17. C.Crawford
18. V.Brown

JUNIOR BOYS

1. A.West
2. S.Chrystall
3. S.McLaren
4. C.McRoberts
5. J.Bradshaw
6. T.Hansen
7. E.Stokes
8. T.Head
9. T.George
10. J.Houghton
11. K.Robertson
12. J.Wilson
13. W.Mackrell
14. I.Dooley
15. M.Toto
16. R.Ngawhika
17. D.Williams
18. C.Herdman
19. P.Frangos
20. D.Puncheon
21. D.Bright
22. S.Odlum
23. M.Nikora
24. G.Cleland
25. J.Ryan
26. R.Frampton
27. M.Kaio
28. A.Lewin
29. C.Hartstone
30. C.Bridgeman
31. S.Willey
32. P.Crawford
33. M.Stevens
34. J.Duffull
35. I.Gambrill
36. B.Matenga
37. L.Henare
38. N.Thomsen
39. S.Smith
40. S.Paul

INTERM. BOYS

1. S.Comins
2. D.Brown
3. A.Pharo
4. J.Bell
5. J.Miller
6. B.White
7. R.McSweeney
8. G.Wood
9. J.West
10. S.Johnson
11. P.Williams
12. P.Clarke
13. R.Wall
14. R.Hintz
15. P.Hodgkinson
16. M.Pinkerton
17. O.Allison
18. E.Nikora
19. H.Beckham
20. P.Vandy
21. J.Tahana
22. M.Tournier
23. L.Turner
24. A.Haultain
25. A.Collins
26. K.Simon
27. M.Collis
28. K.McKee
29. A.Paul
30. P.McMillan
31. E.Cathro
32. T.Young
33. B.O'Hearn
34. R.Gutry
35. R.Salt
36. C.Renata
37. K.Morgan
38. M.Mahara
39. S.Jennings
40. P.Magee
41. L.Carroll
42. R.Oliver
43. J.Clark
44. S.Moana
45. G.Savage
46. H.Lovell
47. R.Harris
48. K.Hooker
49. P.Rawiri
50. H.Williams
51. G.Ridley
52. M.Wills
53. D.Taylor
54. J.Robinson
55. M.Ryan
56. R.Hopa
57. M.Williamson
58. A.Holden

59. B.Mahara
60. J.Heremaia
61. R.Coenen
62. T.Chrystall
63. M.Nepia

SENIOR BOYS

1. B.Harding
2. P.Tournier
3. R.Cairns
4. Hekewaru Muru
5. G.Bradshaw
6. S.Solomon
7. R.Connolly
8. R.Wardell
9. Q.West
10. M.VanTiel
11. G.Hopa
12. G.Solomon
13. R.Hodgkinson
14. M.Hintz
15. G.Caddigan
16. S.Whatford
17. B.Windsor
18. J.Henry
19. O.Christie
20. H.Katipa
21. R.Wright
22. W.Muru
23. T.McRoberts
24. K.Magee
25. G.Simon
26. Huranui Muru
27. D.McBurney
28. G.Collis

STAFF

(Placings unsure)
C.Cameron
L.Middleton
R.Wigelsworth
R.Bailey
T.McIntosh
T.West (biked)

FINAL RESULTS

1. Newcastle
2. Tainui
3. Maniapoto
4. Havelock

CROSS-COUNTRY CHAMPIONSHIPS (Waipa Racing Club, Te Awamutu)

The weather gave us sun showers on and off throughout the day and all Ngaruawahia competitors performed very well on the undulating course alongside top talent from other Waikato schools.

Tracey Roe and Wendy Nuzum ran very well in the Intermediate girls' event along with Sheree Parker, who unfortunately had to pull out with leg trouble. Special mention must be made of the Junior runners, especially Ricky White who ran with Dean Brown and Shane Commins in the Intermediate Section so that we would have a team in the event.

-Dean Brown.

CRICKET



"In all matters of opinion our adversaries are insane."
-Twain



Debating



D.Ranga, T.Richardson, J.Bradshaw,
B.Hill, Mr West (Standing).

On the 23rd October our Debating Team of Tanya Richardson, Susan Robertson and John Bradshaw, travelled to the Te Rapa Race-course for the annual debate held for the Te Rapa Rotary Club, against Fraser H.S.

We were warmly greeted by our hosts, the Te Rapa Rotarians who directed us to a magnificently laid table where we helped ourselves to a glorious meal.

After the dinner and the Rotarian business the debate commenced. The topic

was "A University Education is an Expensive Luxury". Ngaruawahia were the negating team and were fully prepared for 5-minute speeches but, alas, there had been a slight misunderstanding and Fraser had prepared 10-minute speeches!

After some panic and confusion it was decided we would leave our speeches as they were and the time difference would be taken into account.

Both teams launched into the debate enthusiastically, both eager to win; for it was the first time we were debating for a trophy instead of just the normal money award. Fraser argued their case with figures and facts while Ngaruawahia added a little extra sparkle and humour to their speeches.

Fraser were fluent speakers and deserved the narrow 70-68 win.

LAMENT ON LOSING

Our Tanya was Witty:
She held Them with her Style,
Or when the Fancy took her,
Charmed from Them a Smile.
But the Judge
Kept totting up the Score!

Our Susan spoke up Bravely
And made a Mighty Case,
But the Words welled up within Her
And she Spoke as in a Race.
And the Judge
Kept Totting up the Score!

Our John was Strong on Humour;
Interjected loud and clear.
But the Enemy was Mighty -
Did not our Fellows fear.
And the Judge
Kept Totting up the Score!

LIFE-SAVING²²

This year saw many newcomers from the 3rd 4th and 5th forms, showing an increasing popularity of life saving in the school.

With much time consumed in lunch hours learning, practising and training at the Ngaruawahia Pools, each candidate was successful in achieving their award when it came to exams.



Karen Singh



Matthew Stevens

- Instructors -
 Beverly Cleland
 Marguerite Esselbrugge
 Wendy Nuzum
Bronze Cross -
 Claire Hartstone
 Vivienne Taylor
Award of Merit -
 Raymond Connolly

DECEMBER 1979: Elementary Certificate -



Sandra Houghton

- Louise Harrop
 Linda Park
Bronze Medallion -
 Linda Scott
 Beverly Cleland
 Tracey Roe
 Marguerite Esselbrugge
Bronze Cross -
 Wendy Nuzum
 Sandra Fisher
 Margaret Collins

MARCH 1980: Intermediate Star -



Paul Crawford

- Loretta Gielen
 Gayle Hartstone
 Vivienne Head
 Paul Crawford
 Matthew Stevens
Bronze Medallion
 Rhonda Commins
 Jan Plummer
 Karen Singh
 Zane Cathro
 Sandra Houghton
 Clifford McRoberts
 Justin West
 Brandon Williams
 Gary Mudgway



Jan Plummer

April saw the second representation of our school in the Inter-School Life Saving Competition Relays. A girls team of Wendy Nuzum, Claire Hartstone, Marguerite Esselbrugge and Rhonda Commins and a boys' team of Brandon Williams, Raymond Connolly, Clifford McRoberts and Zane Cathro. Although the teams were unsuccessful, the representatives enjoyed themselves thoroughly.

Gratitude is owed to Mr Mains for his giving up his lunch hours to pass on his knowledge. He is the President of the Waikato Life Saving Association for the 1979-1980 season and this gave us an extra advantage. We are all going to miss his participation next year as he is leaving the school. We will have to hope that we can flourish successfully in the Royal Life Saving Society without him!

Raymond Connolly

Great win for Gary!

Gary Mudgway



16-YEAR-OLD apprentice Gary Mudgway Jr will always hold the fondest memories of Rotorua.

By IAN BROWN

Mudgway, a pupil at Ngaruawahia High School and apprenticed to his father who prepared the mighty Silver Nymph, gained the biggest thrill of his lifetime on that track yesterday.

Cool, calm, and collected, Mudgway Jr gained his first winning ride when he hands and heeled the Te Rapa colt Wanderville down the Rotorua stretch to win the "So Vain" Handicap.

Able to ride at 46kg, Mudgway should not be lacking in opportunities from now on.

A jubilant Mudgway Sr was the first to sprint from the top of the stand to offer congratulations to his son.

"I didn't have to yell

for Silver Nymph last week," he said.

"But, gee, I certainly made up for it today."

Mudgway, who sits School Certificate this year, was having only the fifth ride of his career.

"All I can say is a real big thanks to Wanderville's trainer, Norm Crawford. If it hadn't been for him giving me the mount I guess I wouldn't have been here today," he said.

Only ride

Wanderville was Mudgway's sole riding engagement for the day.

Hockey

GIRLS' "A"

This season the "A" Team was promoted to a higher Grade than 1979, so faced tough competition. The girls pulled together to provide a very forceful attacking unit, gaining many well-deserved victories balanced by as many losses. However wet muddy conditions never seemed to hinder their game.

The "sideline" players (faithful parent supporters, coach (Mr Samujh) and manager (Mrs Curtis)) always cheered and encouraged us in times of victory and depression.

Mrs McLean and other parents provided backup and support for the team - thanks.

With consistent speed and skill our wings, Tracey Smith and Linda Park, manoeuvred around their opposition to score many superb goals. Providing tremendous backing, Vivienne Taylor and Maggie Taylor picked up loose balls and passed them on to the wings or Sandra Fisher. Sandra was always in position ready to tackle the opposing backs and goalie.

The strong halves, Karrol Hura, Linda McLean and Carolyn Fletcher passed the ball with accuracy to our forwards.



REAR: C.Fletcher, V.Taylor, M.Taylor.
CENTRE: T.Rowe, K.Hura, L.Park, M.Pellow,
S.Robertson, Mr Samujh.
FRONT: S.Fisher, L.McLean, D.Callaghan,
T.Roe.

23 They were followed by Sandra Robertson and Tracey Roe in defense. Opponents had a hard time against our "lifesaver" Dorothy Callaghan who was positioned in our desolate goal. Thanks go to our reliable reserves in Michelle Pellow and girls in the "B" and "C" teams. Thanks to Mr Samujh and Mrs Curtis who got the team off the ground - we appreciate their support.

-Tracey Smith/Linda McLean

GIRLS' "B"

The team has had a successful year competing at Innes Common despite mud and slush. They ventured on through the season with good spirit and a good match record. Fraser was the only team to take 2 points off them with a 1-0 victory. This resulted from some experimentation in the team where goalie and forward were swapped!

The team had 11 eager girls and reserves who worked as a unit, acquiring many useful skills and tactics which will be invaluable next year. We thank Angela Bright (Captain) and Mrs Curtis and all the staff who supported us.

-W.Nuzum (V.Capt.)



REAR: G.Runciman, L.Perham, D.Prince,
M.Barlow, W.Hansen, Mr Samujh.
FRONT: H.Johnston, B.Cleland, A.Bright,
H.McLean, L.Harrop, D.Turton.

GIRLS' "C"

The team has had a remarkable season. Their performance was made even more remarkable when it is considered that over half the team had never played hockey before!

Playing 11 games in the 7th Grade for 11 wins, the girls registered an 85-3 goal tally. Pura Harper top-scored with 31 goals.

The team remained unbeaten in mid-week interschool games as well.

netball

The school fielded three teams this year in the Taupiri Competition.

The 5A team was entered into the 'A grade', in which they met some tough opposition. However they did manage a number of wins.

The valuable experience gained from the Saturday Competition was apparent when the team fared very well in the inter-school games. The results for these games are as follows:

5A vs Huntly	win 32- 9
vs Hillcrest	win 16-15
vs Raglan	win
vs Melville	loss 11-29
vs Te Kuiti	loss 13-15
vs Huntly	win 20-18
vs Papakura	win 18-18
vs Hauraki Plains	win 18-14

The highlight of the season for the A team came when they defeated Papakura High School, (an unbeaten team in their Auckland Competition).

Another triumph for the team came when Lesley Clay, Lulu Clark and Kim TeWiata were selected for the Eastern Waikato Representative trials. Kim gained selection to the B team.

The Eastern Waikato Association awarded a cup for the outstanding playing ability and sportsmanship of High School players. Congratulations to Kim TeWiata and Richelle Parata who share in this fine trophy for the 1980 season.



REAR: R.Parata, Mrs Cameron, K.TeWiata.
FRONT: A.Paekau, A.Heremaia, M.Tukere, L.Clay.

24

The 5B team competed in the B Grade on Saturdays and had a most successful season under the enthusiastic captaincy of Mere Morgan. Consistent Saturday turnout, a good team spirit and talented play produced some excellent results for this team, who came runners-up in the B Grade Championship and won the handicap day at Taupiri.

Interscholar fixture results:

5B v. Hillcrest	13-12
v. TeKuiti	15-19
v. Hauraki Plains	12-7
v. Huntly	24-24
v. Papakura	20-15



REAR: M.Ranga, Mrs Cameron.
FRONT: A.Nepia, R.Tini, M.Morgan.

Thanks must go to Mrs Dixon and Hohi Daniels who coached and supported the 4A Team. Although match results are not available, they had a good season and were placed highly in the competition (B Grade).



REAR: Mrs Dixon, W.Gibb, R.Bidois, N.Gray, H.Daniels.
FRONT: M.Mahara, T.Henare, M.Tai, J.Graham, A.Hopa.

"I'm a second eleven sort of chap."
-Barrie



REAR: F.Crowther, K.Takata, K.Perham,
Mr Samujh, P.Harper, A.Baird, S.Mahara.
FRONT: L.Rogers, J.Plummer, D.Renete,
K.Singh, L.Mills, K.Rogers.



REAR: Mr Clark, S.McLaren, A.Holden,
G.Oliver, R.Connolly, S.Schrieber,
G.Wood, Mr Mains.
FRONT: M.Tournier, C.Herdman, S.Roe,
L.Callaghan, M.Stevens, C.Gutry,
G.Mudgway, R.Coenen.

BOYS HOCKEY

BOYS HOCKEY

Good results have been achieved this season, in the third year the school has entered in the competition. Everybody combined well and worked as a team and with good spirit won the 4th Grade Saturday competition and received the Clark Shield for Junior Boys' Hockey.

Our left winger, Scott Schrieber, scored 20 of our 50 goals, providing a good melding with the other front-runners. Our defense did its part too, with tactics and skill from Gary Mudgway, Steven Roe, Lance Callaghan, Raymond Connolly, Grant Oliver, Ricky Coenen and Matthew Stevens in goal.

The highlight of the season was a well-earned trip to Taumaranui, where we had our first loss of the season. We didn't disgrace ourselves and worked well to score a goal in our 5-1 loss. We enjoyed the company of our hosts and the next day enjoyed the snows of Mount Ruapehu.

Thanks to Mr Mains who put up with us during training sessions. He and Mr Clark helped tremendously with the success of this year's team.

-Craig Gutry (Capt.)



Mark Edwards Lisa LaGrand Shane Graves

HARRIERS

REAR: D.Andrews, R.Hintz, H.Lovell,
P.Didovich.
CENTRE: V.Head, D.Brown, S.Graves,
S.Chrystall, R.Davies, Mrs Middleton.
FRONT: B.Dalbeth, S.Dass, B.Wright,
D.Barakat, M.Esselbrugge.



"...the muddled oafs at the goals".
-Kipling



RUGBY

The 1980 season proved to be one for rebuilding after the successes of 1979. With only three players returning from last year's team, it was a credit that this season's squad, despite its inexperience, was able to finish so high up in the Secondary School's first division.

The team, despite coming from the smallest school in the first division, was still able to record impressive wins against the top teams of several much larger schools. Perhaps the most notable of the season's highlights were the victories over Matamata (19-17) and Melville (16-10), and the narrow loss (0-6) to Putaruru in a Tricolour Trophy challenge match.

Three players stood out and all three were selected for Waikato Secondary Schools' sides for the Hughes and Cossar Tournament. They were Glenn Solomon, Greg Bradshaw and George Simon. Glenn was also selected for the Waikato Under-18 side, and was named as fullback in the Northern Region Tournament team - the first time the school had been represented in this team.

In addition Ross Wall, Waata Muru and Joseph Tahana were selected for the Hamilton Secondary Schools' side which played the touring Gordon Representative side from Sydney.

Of all the players however, special mention must be made of George Simon who was an outstanding leader and captain, and Glenn Solomon who, for the second year in a row, easily topped the Century of points with his 123 points from 6 tries, 15 conversions, 18 penalties and 5 drop goals. Although rugby is a team game these two did stand out.

Mention must also be made of Dale Timms, Joseph Tahana, Grant Johnston and Robert Wright, all of whom were playing



REAR: M.Hintz, D.Wise, R.Wright, J.Tahana, G.Bradshaw, R.Wall, G.Johnston.

CENTRE: Mr Grinter, J.Henry, Q.West, W.Muru, D.Timms, J.West, Mr Murphy.

FRONT: B.O'Hearn, G.Caddigan, G.Simon, G.Solomon, P.Tournier, B.Windsor.

their first real season of Rugby and all became key members of the team. The remaining players in their first season of 1st 15 rugby all played well, and showed great improvement over the season.

With the prospect of several of this year's team returning to school in 1981, there is the promise of even better things to come from this keen and spirited team.

Our thanks go to the many who contributed so much to this team; in particular Tony McIntosh who assisted with the coaching, Colin Keast with the management, and the charming (and now famous) tea girls with the refreshments...not to forget those who supported the team regardless of weather or nerves.

Finally I would like to thank all the team for the way they strived to play exciting rugby and represent their school well. In the end it is these qualities that provide the measure of a team.

-A.C.GRINTER (Coach)

1st 15
RECORD

	For	Ag.
v. Hauraki Plains	16	0
v. Cambridge	26	27
v. Otorohanga	3	7
v. Fairfield	9	9
v. Putaruru	0	6
v. Hillcrest	15	6
v. Tokoroa	6	39
v. St John's	6	23
v. Fraser	6	0
v. C.C.N.Z.	0	22
v. Cambridge	17	9
v. Te Kuiti	30	3
v. H.B.H.S.	6	12
v. Melville	16	10
v. St Paul's	3	15
v. Waikeria	32	0
v. Hauraki Plains	6	6
v. Matamata	19	17
v. Te Awamutu	9	19
v. Huntly	6	30
v. Papakura	24	22
	<u>255</u>	<u>282</u>

Played 21; Won 9; Drew 2, Los

27 4th XV RUGBY

The season has been fairly good with large wins against Huntly and Morrinsville.

The high lights of the season were against St Johns College and Te Awamutu College. St Johns were the top Waikato team with the strongest 7th grade forward pack around, that was until we arrived! Throughout the game we pushed their pack off the ball and won about half of the tighthead. The team must be commended on the excellent show of rugby. Te Awamutu's game was played under horrific conditions - the field was a sea of mud and the rain poured down throughout. The ball was greasy and it was freezing cold. It even started to hail in the second half! Even in the rotten conditions the team still turned up trumps.

The team owes its success to the Coach Mr J. Clayton, whose dedication to the team was unflinching. He even came back from Whitianga to take us into play! Also the support shown by Mrs Robertson who attended every game was appreciated by all.

All in all it has been a fairly successful season for the team, even if we did get THRASHED by Putaruru.



REAR: G.Savage, T.McRoberts, A.Keiser, M.Kaio, A.Haultain, D.Miller.
CENTRE: Mr McIntosh, J.Tairakena, M.Winikerei, G.Hopa, J.Robinson, Mr Mans.
FRONT: R.Harris, M.Ryan, E.Nikora, Z.Cathro, A.Collins.



REAR: K.Robertson, S.Moana, M.Sarney, A.West, P.Clarke.
CENTRE: B.Carter, R.Ngawhika, S.Johnson, M.Collis, M.Mahara, J.Houghton, Mr Clayton.
FRONT: J.Wilson, K.Hooker, R.Gutry, D.Lauder, T.Head, E.Stokes.



Lee Henare



Nigel Edmonds



Hapi Rakena



Kevin Robertson



Kiwi Taka



Craig Bridgeman

Music

28

This year the orchestra consisted of twenty-one members from 3rd form to 6th form level. Even though the group was not large there was always evidence of enthusiasm.

The orchestra performed at a number of events including assembly, the Variety Concert and the annual Prizegiving. Each time they were received warmly.

It is often difficult to get such a group together and many thanks must be given to Mr Johnston for his never-ending patience and participation as conductor. Mrs Storey also deserves thanks for her assistance within the string section; we are very grateful for her time and help. A special mention must also be made of Mr Robb who tried to help out in the brass section, but due to administrative duties and lack of time he wasn't always able to attend.

Orchestra members:

STRINGS	FLUTES
Leanne Tyrie	Glennis Runciman
Hilary Whitfield	Miranda Campbell
Jeanine Dalbeth	Tracey Campbell
CLARINETS	TRUMPETS
Donna Ranga	Ricky Coenen
Judith Hartstone	Robert Wright
SAXOPHONE	E^b HORN
Craig Gutry	John Miller
TROMBONE	BARITONE
Joseph Tahana	Roy Blissett
Raymond Connolly	

RHYTHM GUITAR
Pierre Clarke
Richard Wardell

BASS GUITAR
Michael Williamson

PIANO
Michelle Pellow
Murray Hintz

DRUMS
Rodney Gutry

In addition to the classroom music programme run by Mr Johnston and Mr Braithwaite, the following itinerant teachers have been providing tuition:

Mrs Kane	Woodwind
Mrs Paterson	Vocals
Mr Lee	Brass
Mr McShane	Violin
Mr Townsend	Guitar

REAR: R.Gutry, R.Coenen, R.Blissett, J.Tahana, R.Connolly, R.Wright, J.Miller.
CENTRE: C.Gutry, D.Ranga, J.Hartstone, M.Campbell, T.Campbell, G.Runciman, R.Wardell, Mr Johnston.
FRONT: P.Clarke, M.Hintz, J.Dalbeth, L.Tyrie, H.Whitfield, M.Pellow, M.Williamson.



REAR: M.Morgan, M.Tukere, L.Henare, D.Pihama, W.Tukere, C.Tengu, A.Nepia.
CENTRE: Mrs Dixon, M.Mahara, A.Paekau, K.Takata, P.Harper, M.Turner, J.Graham, Mrs Ngataki.
FRONT: R.Tini, T.Henare, M.Tai, W.Apiata, A.Heremaia, L.Clay, W.Tukere.

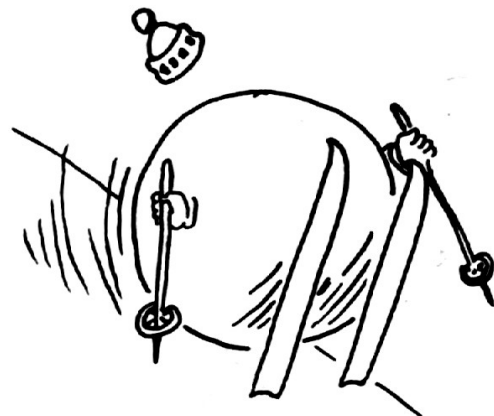

SKIING WITH WIGELSWORTH

Maopi Culture

3rd XV RUGBY

This team was not a Saturday playing team and therefore suffered from not having regular matches.

However, what the team lacked in these opportunities they made up in playing entertaining and amusing rugby.

Able led by Raymond Salt, whose strong running was a feature of many games, the team performed creditably in all of their matches. Mention should also be made of Tim Hansen, Paul Hodgkinson and John Wright whose regular training attendances and keenness greatly improved their rugby skills. Also some crashing runs by Shane Pompey, Maurice Kaio and Charlie Tengu inspired the team, on occasion to lift their efforts.

A fine win against Raglan, plus a determined first half against Huntly in which two passing movements featured the entire 15 players were the highlights of the season.

Overall, the team had an enjoyable season plus the opportunities for many exciting movements to be retold and relived after the matches.

R. Wigelsworth

Rowing



REAR: R.Parata, Mrs Dixon, K.TeWiata
FRONT: M.Morgan, J.Graham, M.Ranga



JOE RYAN

GEORGE SIMON

ALAN COLLINS

We have had our share of representatives this year within the Waikato area as well as a New Zealand rep.:

- * Waikato Rugby League Under 13 years:
 - Joe Ryan
 - John Bradshaw
- * Waikato Rugby League Under 15 Years:
 - Shane Pompey
 - Hekewaru Muru
 - Joseph Heremaia
 - Keith Simon
 - Mark Simon
- * Waikato Under 15 Badminton:
 - Kim Rogers
- * Waikato Junior Indoor Bowls team:
 - David Wise
- ** New Zealand Schoolboy League team:
 - Hekewaru Muru

- * Waikato Secondary Schools "B" Hockey:
 - Tracey Smith
- * N.Z. Barefoot Skiing Championships:
 - Rodney Gutry (Bronze)
- * Waikato Secondary Schools Rugby:
 - Glenn Solomon
 - George Simon
 - Greg Bradshaw
- * Waikato Under 18 Rugby:
 - Glenn Solomon
- * Northern Region Rugby squad:
 - Glenn Solomon
- * Hamilton Secondary Schools' Rugby Squad:
 - Ross Wall
 - Waata Muru
 - Joseph Tahana
- * Eastern Waikato Netball Association:
 - Kim TeWiata (B Team)

David Wise, Roy Blissett and Alan Collins entered the Waikato Secondary Schools Indoor Bowls competition in Hamilton. Roy won one of his matches while Alan won two, including beating the 1979 Waikato Junior Singles Champion. David was eliminated in the quarter-finals, his play consolidating his inclusion in the Waikato Junior Reps.



SOCCER



"Please, Mr Phillips! It wasn't my fault!"
 "God is always on the side which has the best football coach." -Broun



REAR: K.Moana, J.Bell, M.Edwards,
 D.McBurney, R.Cairns, P.Warren, Mr Phillips.
 FRONT: I.Roberts, G.Ridley, R.Wardell,
 B.Harding, K.McKee, K.Magee.

1st ELEVEN SOCCER

The team played 20 games this season winning eleven, scoring 60 goals and conceding 42.

The team ended the season in fifth spot in the Second Division. In the H.M.N.Z.S. Waikato Trophy for all 1st Elevens, the boys came up against a strong Cambridge side and were eliminated.

The most outstanding player over the season was John Bell with Gary Ridley being the most improved.

2nd ELEVEN SOCCER

These boys provided a valuable backup for the senior team.

They found the competition difficult, winning five games for the season, and the team is to be commended for their dedication.

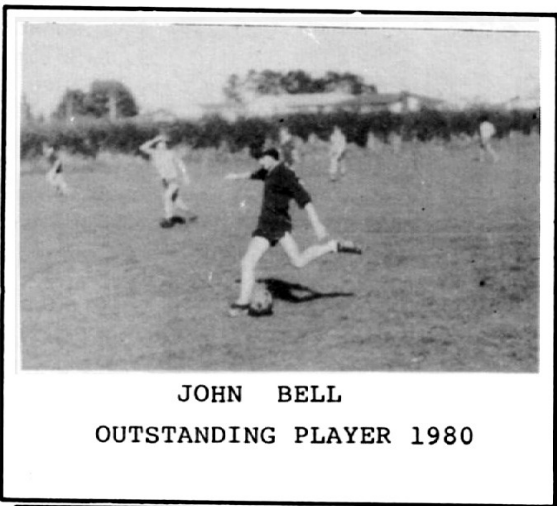

JOHN BELL
 OUTSTANDING PLAYER 1980



REAR: M.Scott, O.Allison, G.Fletcher,
 Mr Braithwaite, Mr Phillips, S.Smith,
 S.Miller, D.Bright.
 FRONT: M.Wills, A.Pharo, E.Cathro,
 P.Magee, D.Hodge, J.Hitchens, T.Young.

SWIMMING

JUNIOR GIRLS

- 1x Freestyle: 1. D.Turton
2. J.Plummer
3. S.Houghton
- 1x Backstroke: 1. J.Plummer
2. S.Houghton
3. A.Powlesland
- 1x Breaststroke: 1. J.Plummer
2. S.Houghton
3. L.Ridley
- 3x Freestyle: 1. D.Turton
2. J.Owens
3. L.Kitto
- 3x Backstroke: 1. D.Turton
2. K.Singh
- 3x Breaststroke: 1. J.Plummer
2. D.Turton
- 3x Medley 1. D.Turton
2. J.Plummer
S.Houghton



Amanda
Powlesland



Leanne
Ridley



Lisa
Kitto



Maria
Prendergast



Clifford
McRoberts



Danny
Williams



Martin
Scott



Shane
Odlum



Shane
Solomon

JUNIOR BOYS

- 1x Freestyle: 1. C.McRoberts
2. A.Haultain
3. D.Williams
- 1x Backstroke: 1. D.Williams
2. K.Simon
3. M.Scott
- 1x Breaststroke: 1. K.Simon
2. S.Odlum
- 3x Freestyle: 1. A.Haultain
2. C.McRoberts
3. T.Young
- 3x Backstroke: 1. C.McRoberts
- 3x Breaststroke: 1. C.McRoberts
- 3x Medley: 1. C.McRoberts
2. T.Young

INTERMEDIATE BOYS

- 1x Freestyle: 1. J.West
2. R.Wall
3. G.Mudgway
- 1x Backstroke: 1. D.Miller
2. G.Mudgway
3. R.Wall
- 1x Breaststroke: 1. E.Nikora
2. Z.Cathro
3. D.Miller
- 3x Freestyle: 1. R.Wall
2. Z.Cathro
3. G.Mudgway
- 3x Backstroke: 1. R.Wall
- 3x Breaststroke: 1. B.Williams
2. Z.Cathro
- 3x Medley: 1. Z.Cathro
2. B.Williams
3. D.Miller

SENIOR BOYS

- 1x Freestyle: 1. G.Simon
2. R.Connolly
3. G.Cathro
- 1x Backstroke: 1. G.Solomon
2. S.Solomon
3. G.Cathro
- 1x Breaststroke: 1. G.Solomon
2. R.Connolly
3. S.Solomon
- 3x Freestyle: 1. G.Simon
2. R.Connolly
3. G.Solomon
- 3x Backstroke: 1. G.Simon
2. S.Solomon
3. G.Solomon
- 3x Medley: 1. R.Connolly
2. G.Solomon
3. G.Simon

BOYS OPEN EVENTS

- 6x Freestyle 1. C.McRoberts
2. R.Connolly
A.Haultain
3. A.Haultain
- 1x Butterfly 1. G.Simon
2. C.McRoberts
3. R.Connolly

INTERMEDIATE GIRLS

- 1x Freestyle: 1. M.Prendergast
2. V.McCarthy
- 1x Backstroke: 1. M.Prendergast
2. V.McCarthy
- 1x Breaststroke: 1. V.McCarthy
- 3x Freestyle: 1. V.McCarthy
2. S.Fisher
- 3x Backstroke: 1. S.Fisher
- 3x Breaststroke: 1. S.Fisher
2. V.McCarthy
- 3x Medley: 1. S.Fisher

SENIOR GIRLS

- 1x Freestyle: 1. V.Solomon
- 1x Backstroke: 1. V.Solomon
2. C.Crawford
- 1x Breaststroke: 1. V.Solomon
- 3x Freestyle: 1. V.Solomon

GIRLS OPEN EVENTS

- 1x Butterfly: 1. V.Solomon
2. S.Fisher
3. W.Nuzum

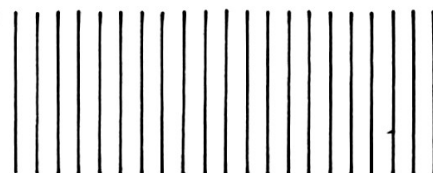

CHAMPIONS

- | | | |
|-------------------|-------------|-------|
| Junior Girl | D.TURTON | _____ |
| Intermediate Girl | V.McCARTHY | _____ |
| Senior Girl | V.SOLOMON | _____ |
| Junior Boys | C.McROBERTS | _____ |
| Intermediate Boys | R.WALL | _____ |
| Senior Boys | G.SIMON | _____ |

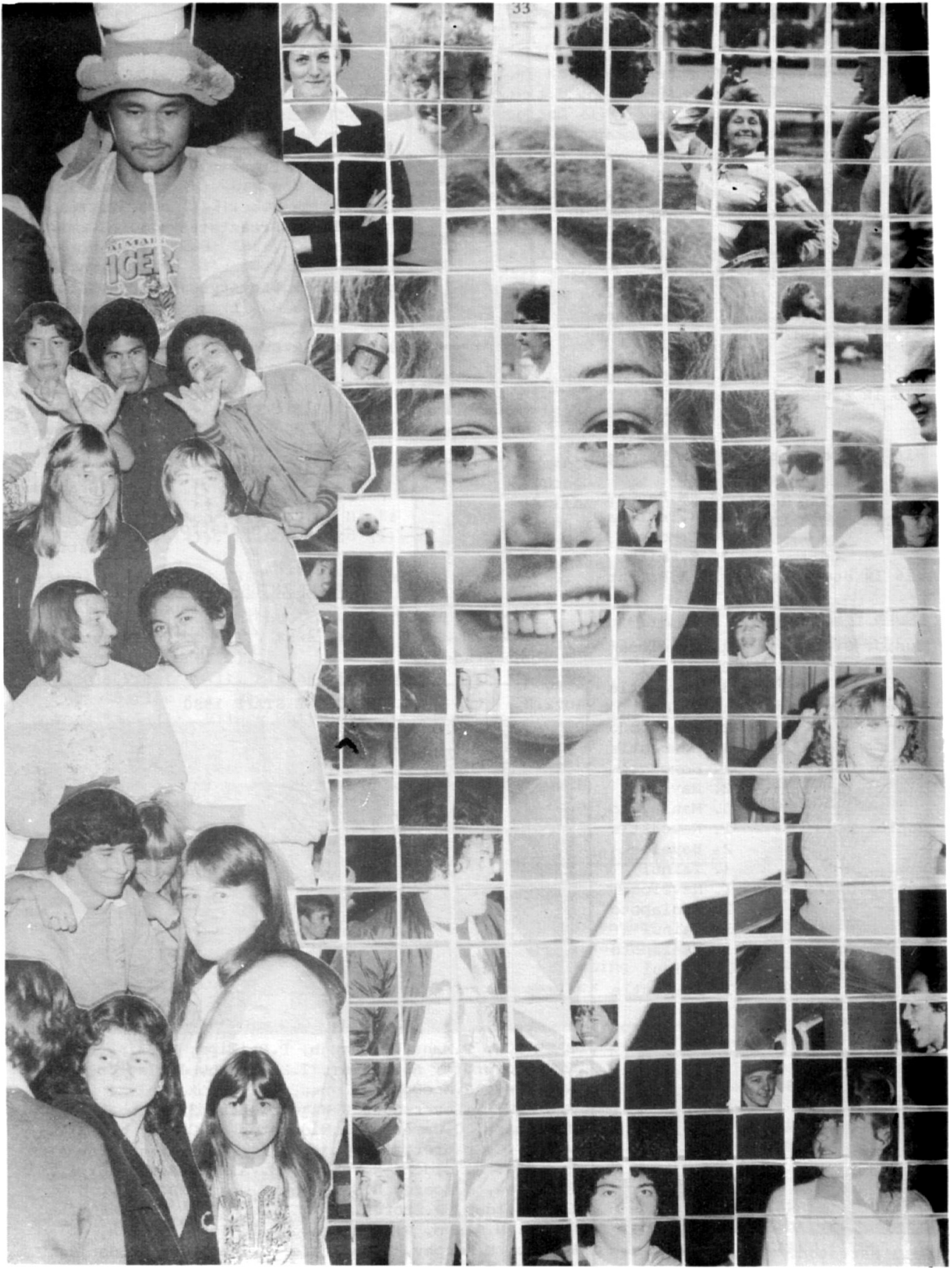

SWIMMING AGE RACES

GIRLS

- 13 1x Freestyle 1. R.Commins
2. K.Rogers
3. L.Rogers
- 13 1x Breaststroke 1. G.Hartstone
- 14 1x Freestyle 1. P.Thackray
2. K.Perham
3. L.Gurnick
- 14 1x Breaststroke 1. L.Solomon
2. P.Thackray
3. B.Law
- 15 1x Freestyle 1. T.Rowe
2. N.Hinton
3. S.McBurney
- 3
- 15 1x Breaststroke 1. S.McBurney
2. R.Parata
3. NM.Morgan
- 16 1x Freestyle 1. B.Wright
2. S.Dyson
3. P.Begbie
- 16 1x Breaststroke 1. L.Vercoe
2. S.
3. M.Ranga
- +16 1x Freestyle 1. K.TeWiata
2. L.McLean
3. S.Smith
- 3
- +16 1x Breaststroke 1. A.Bright

HOUSE RELAYS

- Junior Girls 1. Havelock
2. Tainui
3. Newcastle
- Intermediate Girls 1. Tainui
2. Maniapoto
3. Newcastle
- Senior Girls 1. Newcastle
2. Havelock
3. Maniapoto
- Junior Boys 1. Newcastle
2. Havelock
3. Tainui
- Intermediate Boys 1. Havelock
2. Maniapoto
3. Tainui
- Senior Boys 1. Maniapoto
2. Tainui
3. Newcastle



Gail Hartstone



Maurice Kaio



Derek Lauder



Rhonda Commins



John Bradshaw

34 BOYS

- 13 1x Freestyle 1. J.Bradshaw
2. D.Lauder
3. J.Ryan
- 13 1x Breaststroke 1. J.Ryan
2. J.Bradshaw
3. B.Beddis
- 14 1x Freestyle 1. J.Wislon
2. M.Kaio
3. E.Stokes
- 14 1x Breaststroke 1. A.West
2. K.Robertson
3. B.Borrell
- 15 1x Freestyle 1. B.Betham
2. P.Andrews
3. A.Collins
- 15 1x Breaststroke 1. M.Simon
2. M.Tournier
3. D.Andrews
- 3
- 16 1x Freestyle 1. B.Harding
2. T.McRoberts
3. J.Waters
- +16 1x Freestyle 1. M.Hintz
2. G.Bradshaw
3. G.Caddigan
- +16 1x Breaststroke 1. G.Bradshaw
2. R.Katipa

GROUP INTER-HOUSE RELAYS

- 1. Maniapoto 2
- 2. Havelock 1
- 3. Maniapoto 6

HIGH SCHOOL STAFF 1980



BACK ROW: P.Mans, P.Samujh, P.Philips, N.Mains, T.Meadowcroft, A.Paurini, T.McIntosh, J.Clayton, K.Bailey, A.MacDonald.
 3rd ROW: I.Loveridge, R.Wigelsworth, S.Cargo, J.Schaare, C.Cameron, L.Middleton, M.Cargo, W.Braithwaite, C.Grinter, A.Johnston.
 2nd ROW: J.Holden, K.Vallet, S.Vallet, B.Paurini, P.Barlow, J.Moore, B.Sampson, C.Walsh, D.Ashby, L.Schneider, J.Storey.
 FRONT: H.Dixon, B.Esselbrugge, T.West, J.Clark, B.Robb, N.Murphy, L.McNamara, J.Templeton, J.Sarjeant.
 ABSENT: M.Curtis.

PRIZE LIST ³⁵

CONTRIBUTION AWARDS 1980

Students who received Awards for their contribution to school life were:

- (1st, 2nd, 3rd & Honours)
- H1 Quentin West (H), Bryce O'Hearn (1), Sheryl Dyson (1&2), Joy Waters (1), Glen Solomon (1).
- H2 Craig Gutry (2&3), Carey Bullen (2), Bronwyn Mills (1).
- H3 Scott Schrieber (1), Louise Harrop (1), Glennis Runciman (1), Miranda Campbell (1).
- H4 Dale Barakat (1&2), George Simon (1&2), Joseph Tahana (2&3).
- H5 Karen Newport (1&2), Shane Odlum (1), Angelique Bidois (1).
- H6 Susan Sharp (2), Vivienne Taylor (1), Arthur Paul (1), Robert Wright (1).
- M1 Donna Wade (3), Ata Heremaia (1), Donna Ranga (2), David VanWoerden (1).
- M2 Murray Pinkerton (2), Murray Hintz (1), Stephen Rowe (1), Alison Baird (1).
- M3 -
- M4 Judith Hartstone (3&H), Linda McLean (3), Dorothy Callaghan (2).
- M5 Dale Timms (2&3), Michael Tournier (1), Leanee McPherson (1), Rewa Pihama (1), Lynne Hartstone (1).
- M6 Nicole Preston (1), Michael Pokaia (1), Megan Barlow (2), Wendy Hansen (1), Ross Wall (1), Hilary Whitfield (1).
- N1 Waata Muru (1&2), Caroline Pritchett (1&2), Beverly Cleland (1), Valerie McCarthy (1).
- N2 Shelley Campbell (1&2), Joanne Loveridge (H), Paul Tournier (1), Tanya Richardson (1), Belinda Hill (1), Justin West (1).
- N3 Margaret Taylor (1), Murray Wills (1), Sandra Robertston (1), Martin VanTiel (1), Tony McRoberts (1).
- N4 Helen Jennings (1), Raymond Connolly (1), Monica Fitness (1), Neroli McIlraith (1), Ma Hopa (3), Alan Collins (1), Richelle Parata (1), Andrew Haultain (1), Robert Van Woerden (1).
- N5 Michelle Pellow (1), Judith Jennings (1), David Deacon (1), Shane Graves (1), Brett Windsor (1), Wendy Nuzum (1).
- N6 Angela Bright (1&2), Rodney Gutry (1&2).
- T1 Grant Oliver (1&2), Kerry McKee (2),

- T2 Hoki Katipa (2), Leanne Tyrie (2), Maria Prendergast (1), Graeme Cleland (1).
- T3 Elaine VanHoutte (1&2), Shindo Dass (1), Fiona Marwick (1), Lennore Osborne (1), Sandra Houghton (1).
- T4 Lorraine Vercoe (1&2), Shane Solomon (1&2), Joanne Owens (1), Jackie Clark (1).
- T5 Debbie Prince (1), Moana King (1).
- T6 Mark Toto (1), Robyn Harris (1), Heather Dooley (1).

SENIOR PRIZE LIST

CLASS PRIZES FORM 5

Waikato Mathematics	ANGELIQUE BIDOIS
Typing	SANDRA FISHER
Shorthand/Typing	WAINUI PAKI
Woodwork	MURRAY PINKERTON
Engineering	EARL NIKORA
Technical Drawing	KERRY MCKEE
Woodcraft	GRAEME HOPA
Art	RODNEY GUTRY
Economic Studies	WENDY NUZUM
Maori Language	MATTHEW WINIKEREI
	HOHI DANIELS
Geography	VIVIENNE TAYLOR
History	NEROLI McILRAITH
Biology	NEROLI McILRAITH
Mathematics	TRACEY ROE
Science	TRACEY ROE
French	TRACEY ROE
German	TRACEY ROE
English	TRACEY ROE

CLASS PRIZES FORM 6

Home Economics	BRENDA DALBETH
Art	DALE BARAKAT
Maori Language	ATA HEREMAIA
Technical Drawing	ROBERT VAN WOERDEN
Accounting	SHERYL DYSON
Physics	MARTIN VAN TIEL
Economics	CLAIRE HARTSTONE
Mathematics	CLAIRE HARTSTONE
History	HELEN JENNINGS
French	HELEN JENNINGS
Biology	LEANNE TYRIE
Geography	JUDITH HARTSTONE
English	LEANNE TYRIE
	JUDITH HARTSTONE

CLASS PRIZES FORM 7

Biology	MARGARET TAYLOR
Chemistry	MARGARET TAYLOR
English	MARGARET TAYLOR

"I have never let my schooling interfere with my education." - Twain

SPORTS AWARDS

- Robin Bell Memorial Cup - Intermediate Sprint Champion ROSS WALL
- Grinter Cup - Senior boys Athletics GREG BRADSHAW
- Ang-Templeton-Harris Cup - most improved Soccer player GARY RIDLEY
- Waikato Womens' Hockey Association Cup - winners of Grade 7
C TEAM (Dale Renete)
- Waikato Womens' Hockey Association Cup for highest goal average
C TEAM (Dale Renete)
- Kater Cup - most improved Hockey team
B TEAM (Angela Bright)
- Prendergast Shield - most outstanding soccer player JOHN BELL
- Waring Trophy for most improved girls Hockey player TRACEY SMITH
- Waikato Hockey Association Clark Shield for winners 4th Grade
BOYS TEAM (C.Gutry)
- Robson Cup - Boys Badminton Doubles GREG BRADSHAW
ROSS WALL
- Ngaruawahia High School Cup - Girls Badminton Doubles
LYN ROGERS
KIM ROGERS
- Basketball Trophy JOSEPH TAHANA
- Eastern Waikato Netball Association award for sportsmanship & Ability
KIM TE WIATA
RICHELLE PARATA
- Eastern Waikato Netball Association winners of Handicap Tournament
5B TEAM (M.Morgan)
- McIntosh Cup - Outstanding Junior Rugby Player EVAN STOKES
- Daines Cup - Most improved Rugby Player GREG BRADSHAW
- Rugby Club Cup - contribution to Rugby GEORGE SIMON
- Fijian Schools' Rugby Trophy - most Outstanding Player
GLENN SOLOMON
- Founders' Shield - Interhouse Activities
NEWCASTLE (S.Campbell & R.Connolly)
- Davison Cups for Sportsmanship, Athletics, Games & Swimming:
Best all-round Girl VICKI SOLOMON
Best all-round boy GLENN SOLOMON



Dale Renete



Kim Rogers



Lyn Rogers

"No brain is stronger than its weakest think."
Masson

SPECIAL AWARDS

- Whitecliffs Award for Woodwork
DEAN BROWN
- Silver Mallett for Woodwork & Technical Drawing
MURRAY PINKERTON
- Rachael Walker Trophy for Homecraft
DAVID DEACON
- Sloane Cup for Clothing
KIM DONCASTER
- Ian Brownlee Cup for Geography
JOANNE LOVERIDGE
- Jeanne Gilbert Cup for Languages
SHELLEY CAMPBELL
- McNamara Cup for Science
LEANNE TYRIE
- Marsters Cup for Chemistry
MARTIN VAN TIEL
- Ives Cup for Mathematics & Physics
MARGARET TAYLOR
- Speech Contest Winners:
Senior DALE TIMMS
Form 4 BELINDA HILL
Form 3 KEVIN ROBERTSON
- Douglas Slone Cup for Drama
JUDITH HARTSTONE
- Special Award for Best Supporting Role
GARY RIDLEY
- Pharo Prize - Best Secretarial Student
ELAINE VAN HOUTTE
- Contribution to School Music
CRAIG GUTRY
MICHAEL WILLIAMSON
- Dianne Harper Cup - Leadership in Music
JOSEPH TAHANA
- Latta Cup - Special Endeavour in Music
DONNA RANGA
- Maori Trust Award - Leadership in Culture Group
HOKI KATIPA
- Erana Coulter Award for Maori Studies and Contribution to the Community
ATA HEREMAIA
- Best Maori Scholar DALE TIMMS
- Waikato Goethe Society Competitions for 23 schools:
Senior (3rd) SHELLEY CAMPBELL
4th Form (Diploma) BELINDA HILL
- Violet Jolley Cup for Citizenship
MARGARET TAYLOR
JUDITH HARTSTONE
- Collins Cup for Citizenship
CRAIG GUTRY
- Chairman's Prize for Leadership
DALE TIMMS
- Te Rapa Rotary Award for Outstanding Contribution to the School
QUENTIN WEST
- School Leaders' Awards
JOANNE LOVERIDGE
QUENTIN WEST
- D.J.Carter Cup & Medal for Dux
MARGARET TAYLOR

SCHOOL CERTIFICATE SUBJECT PASSES 1979

- (1) ANDERSON Mark
 (4) BARAKAT Dale
 (1) BEGBIE Penny
 (1) BENNETT Karen
 (1) BOND Gordon
 (2) BRADSHAW Gregory
 (1) BRETT Jackie
 (1) BROEKS Keryn
 (5) BROWN Valerie
 (2) CADDIGAN Grant
 (1) CAIRNS Raymond
 (1) CAMPBELL Douglas
 (6) CAMPBELL Shelley
 (1) CARROLL Wayne
 (4) CARSWELL Venita
 (1) CHRISTIE Owen
 (5) COLLINS Mark
 (5) COLLINS Trevor
 (4) CONNOLLY Raymond
 (1) COOK Richard
 (4) CRAWFORD Carol
 (1) DALBETH Brenda
 (2) DERECOURT Dorothy
 (2) DIDOVICH Cheryl
 (5) DOOLEY Heather
 (5) DYSON Sheryl
 (2) FRATER Karen
 (1) GRAHAM John
 (4) GUTRY Craig
 (2) HAGGIE Carmen
 (3) HARRIS Robyn
 (5) HARTSTONE Claire
 (5) HARTSTONE Judith
 (2) HARTSTONE Lynne
 (4) HAZELTON Donna
 (3) HEREMAIA Hariata
 (1) HINTZ Murray
 (4) HIPPOLITE Kenneth
 (1) HODGKINSON Angela
 (5) HODGKINSON Robert
 (2) HOPA Christine
 (1) HYSLOP Brett
 (5) JENNINGS Helen
 (5) JENNINGS Judith
 (4) JOHNSTON Grant
 (1) JOLLEY Susan
 (1) KARENA Lynnette
 (3) KINT Leslie
 (1) LAUDER Debbie
 (2) MATAAFE Sandra
 (1) MAXWELL Barbara
 (1) McILRAITH Neroli
 (2) MCKENZIE Douglas
 (3) MCKENZIE Karen
 (3) McLEAN Carol
 (5) McPHERSON Leanne
 (2) McSWEENEY Eric
 (1) MIDDLETON William
 (2) MILLS Bronwyn
- (2) MILLS Craig
 (3) MILLS Jay
 (2) MONTGOMERY Janette
 (1) MORGAN Maketu
 (1) MORGAN Ranginoho
 (1) MORGAN Tirohanga
 (5) MURU Waata
 (1) NEPIA Jack
 (3) OLIVER Grant
 (2) PARATA Dawson
 (2) PARKER Karyn
 (5) PELLOW Michelle
 (2) POKAIA Michael
 (5) PRENDERGAST Maria
 (4) RAJENDRAM Gordon
 (4) ROBERTSON Sandra
 (3) RUHA Roland
 (1) SAVILLE Wendy
 (2) SCHRIEBER Scott
 (4) SHARP Susan
 (4) SIMON George
 (2) SMITH Avril
 (5) SMITH Susan
 (1) TAHANA Taiuru
 (2) TE WIATA Kim
 (5) TIMMS Dale
 (6) TYRIE Leanne
 (5) VAN HOUTTE Elaine
 (5) VAN TIEL Martin
 (5) VAN WOERDEN Robert
 (1) VERCOE Lorraine
 (1) VITTE Sabina
 (1) WADE Treve
 (1) WAHANGA Danny
 (1) WARREN Philip
 (3) WATERS Jeffrey
 (2) WATERS Joy
 (1) WILLIAMS Sian
 (4) WILSON Liane
- (Adults)
 (2) NIKORA Alica
 (1) TAWHAI Margaret



"Brain: the apparatus with which we think we think."
 -Bierce

UNIVERSITY ENTRANCE SUBJECT PASSES

- (2) BARLOW Megan
 (1) BRIGHT Angela
 (4) BROEKS Keryn
 (5) BULLEN Peter
 (1) CALLAGHAN Dorothy
 (2) CAMPBELL Douglas
 (4) COENEN Martin
 (2) DYSON Brett
 (4) FAIREY Diane
 (4) FAIRWEATHER Jan
 (4) FLAY Brian
 (5) FOX Murray
 (1) FULLER Paula
 (5) HARPER Brian
 (4) HARTSTONE Karen
 (5) HENRY Brenda
 (4) HOLDERNESS Anne
 (5) HOUGHTON Mark
 (4) JERAM Mena
 (4) LOVERIDGE Joanne
 (4) MIDDLETON Martin
 (4) MURU Dale
 (5) PARK Betty-Marie
 (1) PLUMMER Lynne
 (4) PRENDERGAST Stephanie
 (5) ROGERS Joanne
 (5) SNIJDERS Robert
 (5) TAYLOR Margaret
 (5) TE WIATA Manaia
 (4) VAN WOERDEN Ian
 (5) WEST Quentin
 (5) WILSON Bruce
 (5) WILSON Jaqueline



Treve Wade

BURSARY EXAMINATION 1979

- HARROP Peter "A"
 ROBERTS Bruce "A"
 SCHWASS Michael "B"



Jackie Brett



Heather Dooley



Maggie Taylor

INMATES 1980 ³⁸

★ HAVELOCK 1

ANDREW David
ASHLEY Bronwyn
BEDDIS Caroline
DYSON Sheryl
GIELEN Loretta
HOPA Robert
JOSEPH Peri
LIDDELL Colin
MAXWELL Barbara
McROBERTS Clifford
MURRAY Ian
MAHARA Shona
NIKORA Tony
OHEARN Bryce
PUNCHEON Dean
ROGERS Kim
REYNOLDS Tracee
TEKATA Kahu
WANAKORE Robert
WATERS Joy
WEST Quentin
SOLOMON Glenn

★ HAVELOCK 2

ASHLEY Karen
BULLEN Carey
BECKHAM Harley
BIDOIS Roseline
EDMONDS Diane
GUTRY Craig
GRAY Christine
LIDDELL Rion
MILLS Bronwyn
MILLER John
McLEAN Heather
MORUNGA Allison
MAXWELL Kathleen
NIKORA Michael
NIKORA Paul
OLIVER Ross
PILLING Lisa
ROGERS Lyn
SCOTT Martin
SMITH Mini
TAKA Kiwi
WILLIAMSON Laurie

★ HAVELOCK 3

ASHLEY Dianne
BELL John
BELL Raewyn
CAMPBELL Miranda
COMINS Rhonda
DALBETH Jeanine
FULLER Paula
HARROP Louise
JOSEPH James
McPHERSON Judy
MAHARA Manaki

McSWEENEY Robert
MYERS Sandra
MEAGHER Lisa
GRAY Aaron
PAIKEA Leslie
RUNCIMAN Glennis
SCHRIEBER Scott
SAVILLE Wendy
SMITH Wendy
SARGENT Denise
TAYLOR Robyn
WORKMAN Lynette
WAIWIRI Peter
WAIWIRI Paul
WESTON Neil
WHAREAITU Max

★ HAVELOCK 4

BARAKAT Dale
BRIDGEMAN Gary
BENNENBROEK Trusjie
BENNETT Warren
BRIDGEMAN Craig
BEDDIS Bryan
BORRELL Brett
BRIGHT David
CAMPBELL Tracey
DAVIES Dianne
FRATER Karen
HEAD Vivien
JOSEPH Nigel
JOSEPH James
LAWRY Heather
MOANA June
MATATAHI Arthur
NEPIA Angela
ORMSBY Graham
OSBORNE Sarah
POMPEY Shane
PANAPA Julie
PAKI Wainui
SIMON George

★ HAVELOCK 5

SCANDLYN Patricia
SEFTON Leanne
SIMON Rahui
SCANDLYN Patricia
SEFTON Leanne
SIMON Rahui
TAHANA Joseph
WADE Treve

BRADSHAW Greg
BROEKS Martin
BARAKAT Carla
BIDOIS Angelique
BETHAM Bruce
DASS Bimla
ENGLAND Donna
EDMONDS Lionel

HENRY John
KEELTY Craig
MILLER Dean
MOANA Joanne
NGAWHIKA Richard
NEWPORT Karen
ODLUM Shane
PAUL Scott
PAEKAU Aroha
PHARO Andrew
RANGI Arthur
TAI Richard
WESTBURY Deborah
WILSON Tina
WILLIAMS Tania

★ HAVELOCK 6

BROWN Dean
BLISSET Roy
DAVIS Connie
EDMONDS Lynette
EXCELL Inger
HINTON Natalie
MOANA George
MOUNTNEY Janet
PAUL Arthur
PAIKEA Michelle
PUNGA Allen
SHARPE Susan
SCHWASS Jane
SINGH Karen
TAYLOR Debbie
TUPAIA Pat
TAYLOR Vivienne
THACKRAY Ivan
WATERS Wayne
WILSON John
WRIGHT John
WARREN Rebecca
WATERS Shanette
WRIGHT Robert

★ MANIAPOTO 1

BRIDGEMAN Wayne
HARTSTONE Gaye
HOPA Rahuia
HEREMAIA Ata
KERAPA Terrence
LANGLEY Lisa
LAUDER Derek
MOEKE John
OCONNOR Allan
PAEKAU Lena
ROBINSON Jeffrey
RANGA Donna
ROBERTSON Susan
SAYERS John
SIMON Sharon
STEPHENS Tracey
SMITH Bruce
STOKES Evan

THURLOW John
TODD Sonya
VAN WOERDEN David
WADE Donna

★ MANIAPOTO 2

ANDREWS Preston
BAIRD Alison
BROWN Gary
CADDIGAN Grant
CALLAGHAN Lance
FRATER Leoni
HAGGIE Carmen
HINTZ Murray
JACOBS Poipoi
KARENA Lynette
LOVELL Howard
MURU Hekewaru
MATENGA Barrett
MANIAPOTO Lillian
PINKERTON Murray
RYAN Martin
ROWE Stephen
SOLOMON Lesa
STEVENS Mathew
TINI Roimata
SKETCHLEY Lillian
TAYLOR Colin
PARATA Rewiti

★ MANIAPOTO 3

ALLEN Jackie
COLLINS Julie
CATHRO Elliot
BEGBIE Penny
GIBB Wendy
HARTSTONE Claire
HODGKINSON Robert
HUNAPO Trevor
KING Clifton
MILLER Stuart
MENZIES Robyn
MACKRELL Keith
NIKORA Rachel
NEPIA Malcolm
PARKE Linda
SARNEY Mark
SMITH Steven
SMITH Susan
TONGA Dawn
TAI Maude
TURTON Denise
SAVAGE Geoffrey
TAHANA Sarah
VAN HOUTTE Eric
VAN TIEL Michael
WILLETS Kim

★ MANIAPOTO 4
CALLAGHAN Dorothy
CAIRNS Raymond

CATHRO Zane
CLARK Lulu
COENEN Ricky
CROWTHER Fay
HOUGHTON Jason
HOPA David
HARTSTONE Craig
HOPA Graeme
HARTSTONE Judith
JOHNSTON Helen
KNIGHT Glenda
MATTHEWS Shane
McLEAN Linda
MURU Hurinui
MAGEE Keri
NEWPORT Darren
NELSON Carla
PAEKAU Reid
PERHAM Leanne
RAWIRI Turu
TAHU Pauline
THURLOW Bronwyn
TAIRAKENA Joe
TUKERE Kiritai

★ MANIAPOTO 5

CARROLL Leo
COMINS Shane
GURMEL Surinder
GURMEL Lakshmi
HARTSTONE Lynne
HONA Joseph
HAZELTON Mathew
JEANES Maree
JACOBS Aue
KATIPA Tia
McPHERSON Leanne
MAHARA Brian
POWLESLAND Amanda
PAEKAU Reuben
PIHAMA Rewa
ROBERTSON Kevin
SOLOMON Vicki
TIMMS Dale
TUKERE Marae
TOURNIER Michael
TAMATI Martha
WATERS Colleen
TAIRAKENA Riki
WAHANGA Gilbert

★ MANIAPOTO 6

THURLOW Megan
BRETT Jackie
CATHRO Grant
CHRISTIE Owen
CLAY Leslie
DAVIS Kevin
CARTER Brent
DOCHERTY Christine
HANSEN Wendy

POKAIA Michael	RICHARDSON Tanya	GRAVES Shane	OLIVER Grant	KATIPA Ray
PRESTON Nicole	TOURNIER Paul	HINTON Nigel	REYNOLDS Maree	KITTO Lisa
PAUL Stephen	WEST Justin	JENNINGS Judith	SIMON Mark	MATAAFE Sandra
RYAN Joseph	WRIGHT Brenda	KNIGHTON Grant	TIPENE Lillian	MORGAN Mere
RAKENA Hapi	WILLIAMS Peter	MARU Tini	WALTERS Jimmy	MABBETT Noeline
RAKENA Uru	* <u>NEWCASTLE 3</u>	MAHARA Richard	WILLEY Rex	McTAINSH Cindy
SMITH Diane	APIATA Juanita	MILLS Linda	* <u>TAINUI 2</u>	OWENS Joanne
TANCRED Sophie	CARROLL Wayne	MURRAY Lindsay	BROWN Valerie	PARATA Heta
TONGA Robyn	DAVIES Roka	NUZUM Wendy	CLELAND Graeme	SOLOMON Shane
TIPENE Maurice	DOOLEY Ian	NGARATATA Karen	DALBETH Brenda	SAMUELS Richard
VANDY Peter	DEACON Kerry	PARK Betty-Marie	EDMONDS Nigel	SCOTT Linda
WHITFIELD Hilary	GRAY Philip	PELLOW Michelle	HAUNUI Wiri	STANNARD Warren
WHITE Riki	GURNICK Leslie	POKAIA Tukua	HENARE Shirley	RIDLEY Leanne
WEST Aaron	HURA Karrol	REA Elizabeth	HODGE David	TUKERE Whiti
WAIWIRI Leanne	KATIPA Waru	RANGA Hinemoa	HARRIS Robert	VERCOE Lorraine
WISE David	LOVELL Loryn	RENATA Jackie	KATIPA Hoki	* <u>TAINUI 5</u>
WALL Ross	McROBERTS Tony	SIMON Keith	McLEAN Alan	COLLIS Graeme
* <u>NEWCASTLE 1</u>	PARNWELL Maria	THOM Nancy	McSWEENEY Colleen	DIDOVICH Cheryl
BOOTH Sharon	PAIKEA Reid	PAIKEA Tina	NELSON Hilda	FRANGOS Paul
CLELAND Beverly	ROBERTSON Sandra	WILLIAMS Brandon	PRENDERGAST Maria	HITCHENS Jimmy
CLARK Pierre	ROBINSON John	WINDSOR Brett	RICHARDS Tracey	HEREMAIA Joseph
DIDOVICH Paddy	RENATA Campbell	* <u>NEWCASTLE 6</u>	SMITH Tracey	HENARE Ben
HODGKINSON Paul	RANGA Maria	BRIGHT Angela	SOLOMON Francis	JENNINGS Stuart
HAUNUI Momo	TAYLOR Margaret	ESSELBRUGGE Marguerite	TYRIE Leanne	INIA Wayne
LAGRAND Lisa	TAYLOR David	GUTRY Rodney	TAHAPEHI Wiari	KING Moana
MURU Waata	THOMPSON Kristine	GRAHAM Janice	TYRIE Michelle	LAW Brenda
MILLS Jay	VAN TIEL Martin	HINTZ Robin	WARREN Philip	MONTGOMERY Janette
MOANA Kingi	WESTON Keith	HEAD Tony	WOOD Gary	MOUNTNEY Susan
McCARTHY Valerie	WILLS Murray	HERDMAN Christopher	* <u>TAINUI 3</u>	MORGAN Karoria
MAGEE Peter	ZIMMERMAN Andrea	CHRYSSTALL Tony	BLACK Adrienne	MAHARA Maine
PRITCHETT Caroline	* <u>NEWCASTLE 4</u>	McBURNLEY Darrel	DASS Shindo	PRINCE Deborah
PERHAM Kay	CONNOLLY Raymond	MIDDLETON Angela	FRAMPTON Rodney	PRINCE Maureen
RAWIRI Peter	CARSWELL Venita	McBURNLEY Sonya	GEORGE Toro	PIHAMA Dean
RIDLEY Gary	COLLIS Michael	McLAREN Stephen	FLETCHER Caroline	ROE Julie
SMITH Michelle	COLLINS Allan	ROE Tracy	HOLDEN Andrew	SKETCHLEY Donald
WARDELL Richard	DEAN Matiu	SIMEON Tiki	HOPA Amy	TURNER Lincoln
WILLIAMS Lynda	DAVIS Tracey	RENETE Dale	HINTON Earl	PARKER Sheree
WETI Tahī	DEACON Faith	TURNEY Mutu	HOUGHTON Sandra	* <u>TAINUI 6</u>
WILLEY Stuart	FRANKHOUSER Gary	THACKRAY Paula	JOHNSTON Grant	BAILEY Betty
WILLIAMS Danny	FITNESS Monica	THOMSEN Neville	McMILLAN Paul	BRADSHAW John
* <u>NEWCASTLE 2</u>	HOPA Mahinarangi	TE WIATA Kim	MARWICK Fiona	CHRYSSTALL Steven
ABERHART Shelley	HAULTAIN Andrew	WILLIAMSON Michael	MONTGOMERY Anne	DOOLEY Heather
ALLISON Owen	JENNINGS Helen	WINIKEREI Matthew	MOEKE Sophie	DANIEL Hohi
CAMPBELL Julie	LAGRAND Dale	* <u>TAINUI 1</u>	OSBORNE Lennore	DONCASTER Kim
COKER Judith	MATTHEWS Aroha	BLACK Jacky	PAUL Shane	FRANKHOUSER Dennis
CAMPBELL Shelley	MARU Kathleen	BUCHANAN Vicki	RICHARDSON Sandra	FLETCHER Grant
EDWARDS Mark	MUDGWAY Gary	CLAY Matua	RINGROSE Helen	HARRIS Robyn
FLETCHER Dereck	McILRAITH Neroli	CRAWFORD Paul	TENGU Charlie	JOHNSTON Stephen
GAMBRILL Iain	NELSON Ricky	CRAWFORD Carol	VANDY Ellen	MURU Manawa
HARPER Pura	PARATA Richelle	FISHER Sandra	VAN HOUTTE Elaine	MAHARA Memory
HILL Belinda	RANSFIELD Mero	GRAY Nita	WATERS Jeffrey	NIKORA Earl
KAIO Maurice	SALT Raymond	HARRIS Janet	* <u>TAINUI 4</u>	PLUMMER Jan
LOVERIDGE Fiona	TUKERE Wynae	HITCHENS Tony	CURTIS David	PAIKEA Reid
LOVERIDGE Joanne	TATA Matthew †	HARDING Brian	CLARKE Jackie	PAIKEA Robert
MOANA Stephen	VAN WOERDEN Robert	HYNDMAN Patricia	DUFFUL Johnnie	TOTO Mark
MACKRELL Warren	YOUNG Trevor	LEWIN Allan	HANSEN Timothy	VITTLE Sabina
PARKER Karyn	* <u>NEWCASTLE 5</u>	MYERS Sandra	HENARE Lee	VINCENT Donna
PUNCHEON Sharyn	DEACON David	MIDDLETON Kay	HOOKE Kevin	WAITERE Leo
RANGA Aina	DOUGLAS Paula	MAGEE Kerry	DERECOURT Dorothy	WHATFORD Shane
ROBERTS Ian	EDMONDS Tai	McNALLY Fiona	JOSEPH Peter	
RAKENA Tatua		MAHU Tania		



OUR OWN TEDDY-BOY

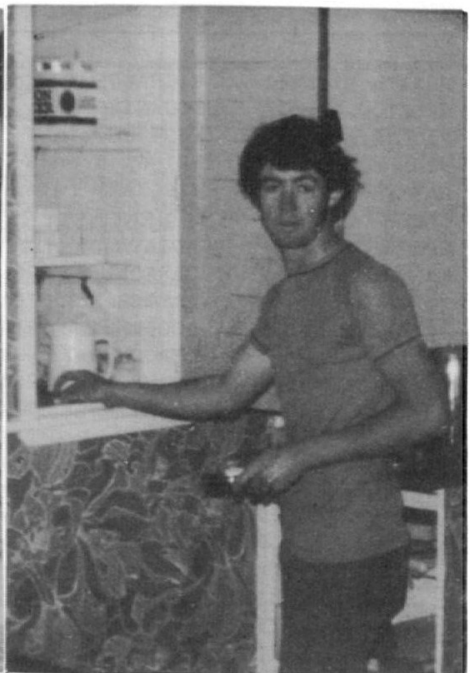

PSSST, TOP SHELF!

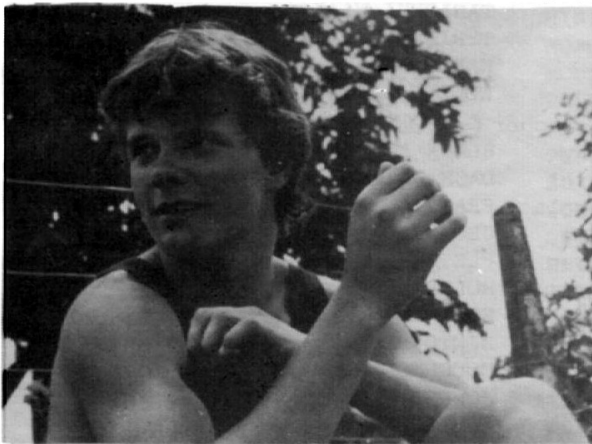

MR MUSCLE



ME?

AUTOGRAPHS

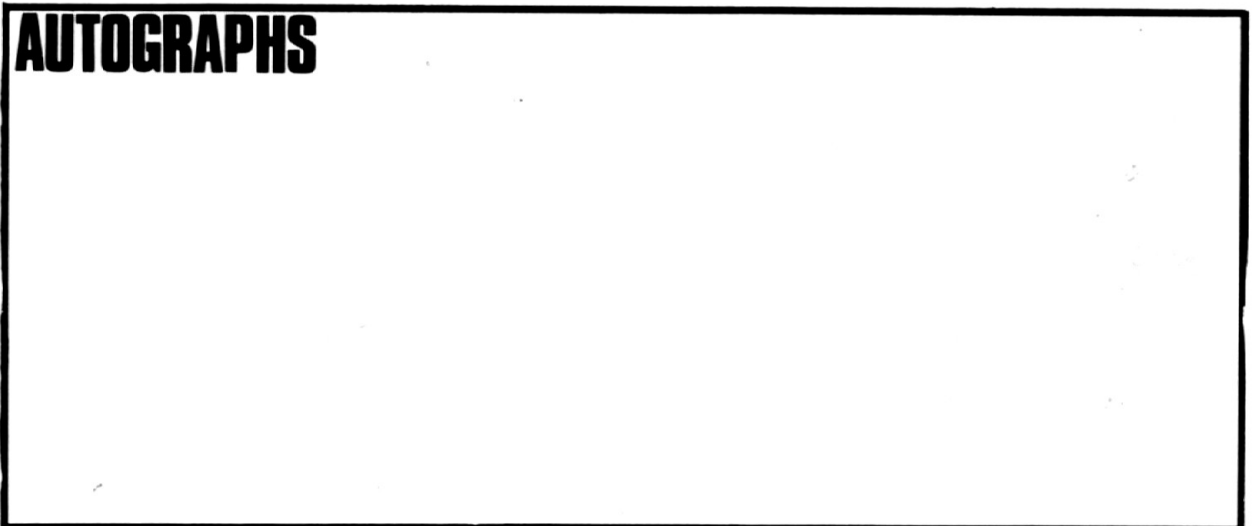

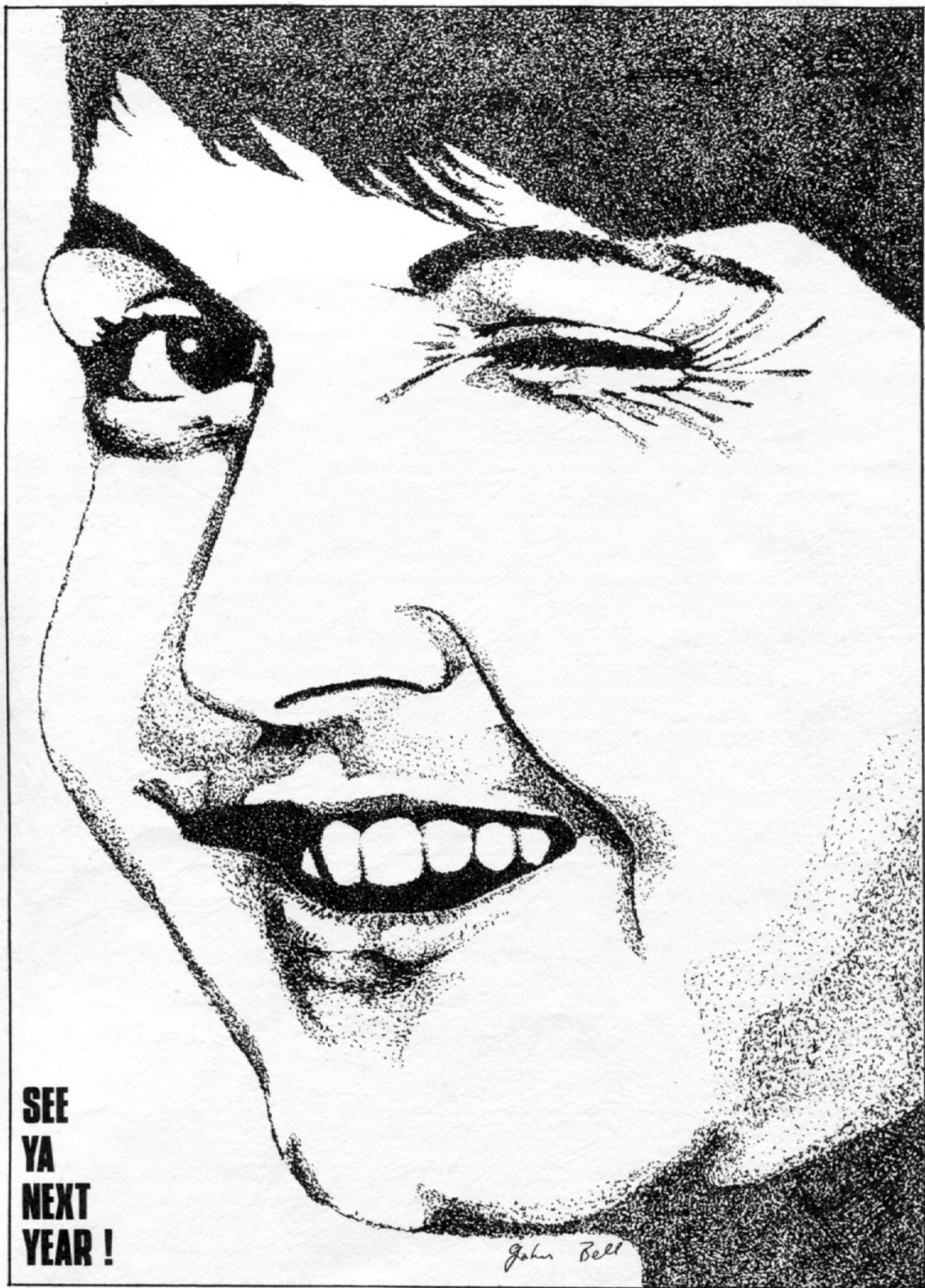

**SEE
YA
NEXT
YEAR !**

John Bell

